

WATER MANAGEMENT



Filtros de malla y anillas en 3/4", 1", 1 1/4" y 1 1/2" en roscas BSP y NPT

Screen and discs filters in 3/4", 1", 1 1/4" and 1 1/2" connections in NPT and BSP threads

FILTMASTER



La herramienta de filtrado más EFICAZ, VERSÁTIL Y RENTABLE

Eficaz: La aplicación de la tecnología más evolucionada da como resultado un alto nivel de rendimiento en el filtrado.

Versátil: Una amplia modulabilidad de los componentes permiten un uso idóneo para cualquier tipo de agua y en ámbitos agrícolas e industriales.

Rentable: El diseño de sus componentes, permite optimizar los ciclos entre limpieza con menor coste energético.

The most EFFICIENT, VERSATILE & PROFITABLE filtering tool.

Efficiency: The application of the most advanced technology results in a higher level of filtering performance.

Versatility: The wide modular capacity of its components allows its perfect use for any kind of water in both agricultural and industrial fields.

Profitability: The design of its components optimizes the cleaning process with lower energetic costs.

Características generales / General characteristics



Roscas NPT/BSP, en 3/4", 1", 1 1/4" y 1 1/2".
 3/4", 1", 1 1/4" y 1 1/2" connections in NPT and BSP threads.



Cuerpo fabricado en termoplástico técnico de alta resistencia PN 10.
 Body injected in high resistance thermoplastic.
 Nominal pressure 10 bars.



Cierre con rosca de alta seguridad con junta tórica integrada en el cuerpo.
 High security thread lock with O-ring integrated in the body.



Salida de purga rosca hembra 1/2" - 3/4".
 Drainage outlet in 1/2" and 3/4" female threaded.



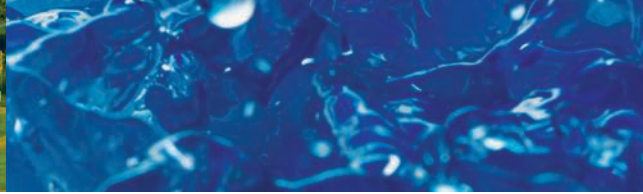
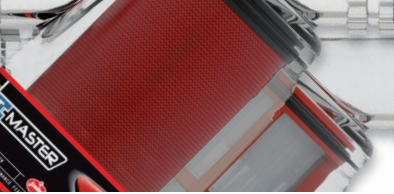

Medios filtrantes / *Filtering elements*



Malla:

- Malla en acero inoxidable AISI 304 con armazón en polipropileno de alta resistencia.
- Base deflectora a la entrada para localizar impurezas en el centro del cartucho.
- Disponible en 100 y 130 micras.

Screen:

- AISI 304 stainless steel screen with high resistance metallic frame and polypropylene tightening rings.
- Deflector base in the entrance locating all the solids in the center of the cartridge
- Available in 100 and 130 microns.

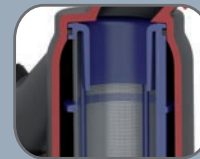
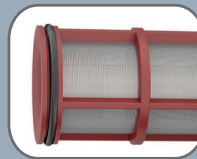

Anilla:

- Anillas de polipropileno, diseñadas para mantener un paso constante, garantizando un MICRAJE REAL.
- Disponible en 100 y 130 micras.
- Armazón en polipropileno, ajuste por presión.
- Tapón extensible para limpieza manual.

Discs:

- Polypropylene discs designed for keeping a filtrate regular flow in REAL MICRONS.
- Available in 100, and 130 microns.
- Polypropilene frame adjustable by pressure.
- Extendable plug for manual cleaning.

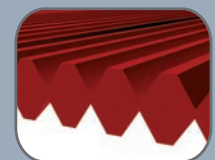
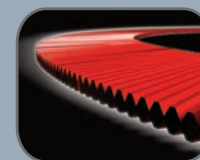
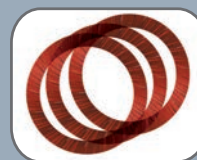



Cotas / General Measures

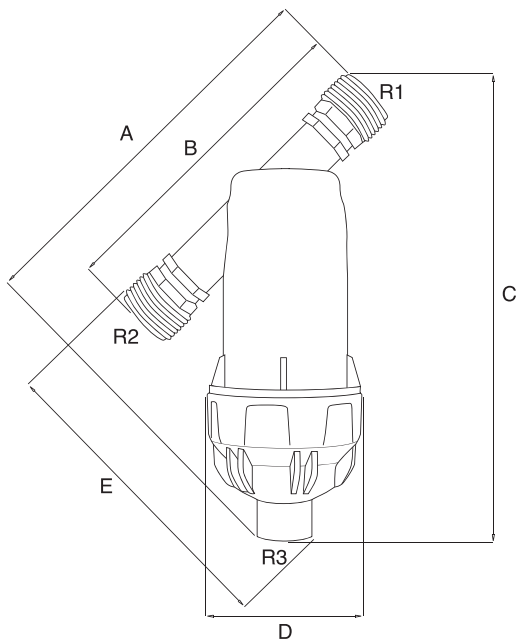

| Roscas BSP / BSP threads | | | | | | | |
|--------------------------|-------|-----|-----|-------|-----|------------|----------|
| Medida / Size | A | B | C | D | E | R1 - R2 | R3 |
| 3/4" | 194,5 | 160 | 231 | 78 | - | 3/4" BSP | 1/2" BSP |
| 1" | 195,5 | 160 | 234 | 78 | - | 1" BSP | 1/2" BSP |
| 1 1/4" | 265 | 243 | 311 | 108,5 | 210 | 1 1/4" BSP | 3/4" BSP |
| 1 1/2" | 265 | 243 | 314 | 108,5 | 210 | 1 1/2" BSP | 3/4" BSP |

| Roscas NPT / NPT threads | | | | | | | |
|--------------------------|-------|-----|-----|-------|-----|------------|----------|
| Medida / Size | A | B | C | D | E | R1 - R2 | R3 |
| 3/4" | 197,5 | 164 | 233 | 78 | - | 3/4" NPT | 1/2" NPT |
| 1" | 202 | 174 | 239 | 78 | - | 1" NPT | 1/2" NPT |
| 1 1/4" | 267 | 246 | 312 | 108,5 | 210 | 1 1/4" NPT | 3/4" NPT |
| 1 1/2" | 267 | 246 | 314 | 108,5 | 210 | 1 1/2" NPT | 3/4" NPT |

Pérdida de carga / Head loss charts

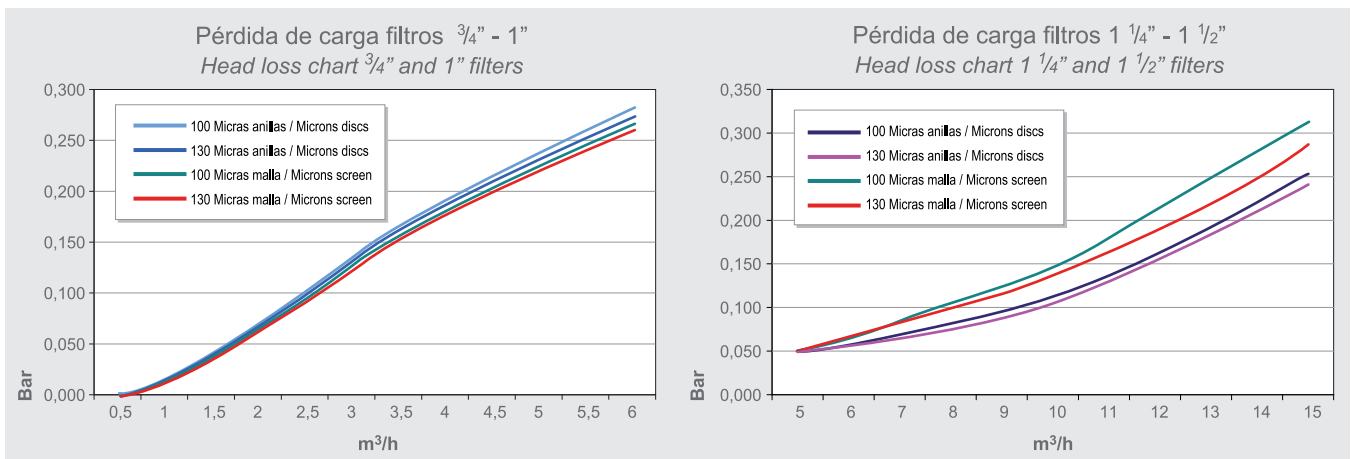

Caudal - Calidad del agua / Flow - Water quality

| Filtros / Filter | Medida / Size | 130 micras / microns | | | 100 micras / microns | | | Superficie de filtración / Filtration surface |
|------------------|-----------------|----------------------|-----|-----|----------------------|-----|-----|---|
| | | A | B | C | A | B | C | |
| Malla / Screen | 3/4" - 1" | 5,0 | 3,5 | 2,0 | 4,8 | 3,3 | 1,8 | 172 cm ² |
| Anilla / Disc | 3/4" - 1" | 4,7 | 3,1 | 1,7 | 4,5 | 2,9 | 1,6 | 195 cm ² |
| Malla / Screen | 1 1/4" - 1 1/2" | 13,0 | 8,8 | 6,7 | 12,5 | 8,3 | 6,2 | 297 cm ² |
| Anilla / Disc | 1 1/4" - 1 1/2" | 12,0 | 8,5 | 6,6 | 11,5 | 8,1 | 5,9 | 322 cm ² |

Total sólidos en suspensión / Suspended solids

| A < 50 ppm | 50 ppm < B < 100 ppm | 100 ppm < C < 150 ppm |
|------------------------------------|--|---------------------------------|
| Río - Embalse River - Reservoir | Canal Artificial Artificial channel | Agua Residual Residual Water |

Micraje - Anillas / Microns - Disc

| Color / Colour | Red | Orange | Blue |
|------------------|-----|--------|------|
| Micras / Microns | 130 | 130 | 100 |
| MESH | 120 | 120 | 140 |



Gama / Range



| X-345 azul / blue 100 micras / microns | X-346 rojo / red 130 micras / microns | medida / size | conexiones / connections | u./ | n° |
|--|---|---------------|--------------------------|-----|-----|
| 91052 | 91060 | " | BSP | 10 | A-2 |
| 91053 | 91061 | 1" | BSP | 10 | A-2 |
| 91054 | 91062 | 1 " | BSP | 5 | A-9 |
| 91055 | 91063 | 1 " | BSP | 5 | A-9 |
| 91056 | 91064 | " | NPT | 10 | A-2 |
| 91057 | 91065 | 1" | NPT | 10 | A-2 |
| 91058 | 91066 | 1 " | NPT | 5 | A-9 |
| 91059 | 91067 | 1 " | NPT | 5 | A-9 |

Filtro de malla / Screen filter.



| X-347 azul / blue 100 micras / microns | X-348 rojo / red 130 micras / microns | medida / size | conexiones / connections | u./ | n° |
|--|---|---------------|--------------------------|-----|-----|
| 91068 | 91076 | " | BSP | 10 | A-2 |
| 91069 | 91077 | 1" | BSP | 10 | A-2 |
| 91070 | 91078 | 1 " | BSP | 5 | A-9 |
| 91071 | 91079 | 1 " | BSP | 5 | A-9 |
| 91072 | 91080 | " | NPT | 10 | A-2 |
| 91073 | 91081 | 1" | NPT | 10 | A-2 |
| 91074 | 91082 | 1 " | NPT | 5 | A-9 |
| 91075 | 91083 | 1 " | NPT | 5 | A-9 |

Filtro de anillas / Disc filter.



NUEVO / NEW

| X-384 naranja / orange 130 micras / microns | medida / size | conexiones / connections | u./ | n° |
|---|---------------|--------------------------|-----|------|
| 91096 | 3/4" | BSP | 10 | A-11 |
| 91097 | 1" | BSP | 10 | A-11 |

Filtro anti algas con compuesto ET520 AM Natural / Anti algae filter with ET 5200 AM natural anti-algae compound.

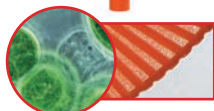

Repuestos / Replacement parts



| Ref. / Code | medida / size | u./ | n° |
|-------------|-----------------|-----|------|
| 91084 | 1" - " 100 M | 5 | A-10 |
| 91085 | 1 " - 1 " 100 M | 5 | A-10 |
| 91096 | 1" - " 130 M | 5 | A-10 |
| 91097 | 1 " - 1 " 130 M | 5 | A-10 |

Repuesto cartucho malla.
Screen cylinder replacement.



| Ref. / Code | medida / size | u./ | n° |
|-------------|-----------------|-----|------|
| 91088 | 1" - " 100 M | 5 | A-10 |
| 91089 | 1 " - 1 " 100 M | 5 | A-10 |
| 91090 | 1" - " 130 M | 5 | A-10 |
| 91091 | 1 " - 1 " 130 M | 5 | A-10 |

Repuesto cartucho anillas.
Replacement ring cylinder.



| Ref. / Code | medida / size | u./ | n° |
|-------------|---------------|-----|------|
| 97792 | " - 1" | 10 | A-10 |
| 97793 | 1 " - 2" | 10 | A-10 |

Junta tórica cierre filtro.
O-ring for filter closure.



| Ref. / Code | medida / size | u./ | n° |
|-------------|---------------|-----|------|
| 97790 | " - 1" | 10 | A-10 |
| 97791 | 1 " - 2" | 10 | A-10 |

Junta tórica cartucho anillas/malla.
O-ring for filter cartridge (screen and disc).



FILT-MASTER

La herramienta de filtrado más eficaz, versátil y rentable del mercado.
The most efficient, versatile & profitable filtering tool.



©JIMTEN 3M

45739 02-14

jimten, SA
CTRA. DE OCAÑA, 125 C.P. 03114
✉ 5285 C.P. 03080
☎ + 34.965.10.90.44
☎ + 34.965.11.50.82
ALICANTE (ESPAÑA)
www.jimten.com



Empresa registrada según norma



ER-0084/1996



GA-1999/0156

an *OAliaxis* company