

Tiled shower tray waste outlets

Vidages pour plateau de douche carrelés

Linum

Camaleon



Sanitary

BUILDING





Tiled shower tray waste outlets

Vidages pour plateaux de douche carrelés



Linum[®]40

Design, cleanliness, adaptability in the same space.

Design, pureté et adaptabilité dans le même espace.

Slot channels for masonry built showers / *Caniveau pour douche à l'italienne*



COMPLETE CHANNEL WITH GRID / CANIVEAU COMPLET AVEC GRILLE

Grid in Stainless Steel with satin finishing.
Central part dismountable.

Grille en acier inoxydable démontable / Partie centrale démontable

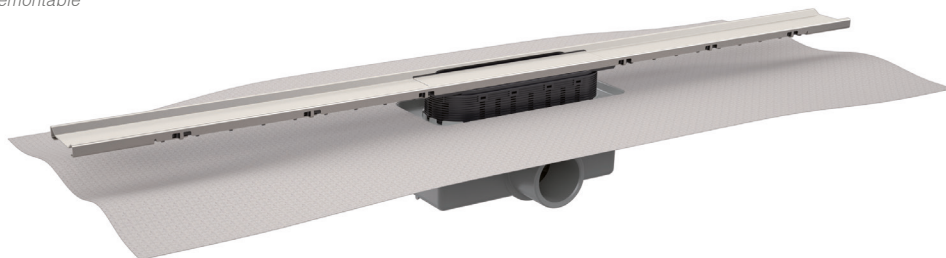

Options of drainage outlets:
Options de sorties d'évacuation:

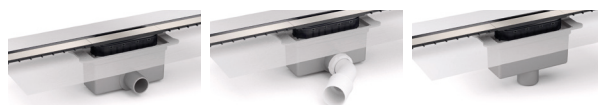

Horizontal outlet 40F/50M solvent socket.

Sortie horizontale 40F/50M à coller.

Horizontal outlet 45° orientable PP male 40/50 mm.

Sortie horizontale 45° orientable PP mâle 40/50 mm.

Vertical outlet 40F/50M solvent socket.

Sortie verticale 40F/50M à coller.

		S-741	S-741	S-742	
Water seal height Hauteur siphon	Long mm Longueur mm	Code	Code.	Code	€
 30 mm	650	013026	013056	013041	212,08
	750	013027	013057	013042	227,55
	950	013029	013059	013044	265,08
 50 mm	650	013036	013066	013046	212,08
	750	013037	013067	013047	227,55
	950	013039	013069	013049	265,08

Channel with grid 40mm width in different length . Registerable trap. Hair filter. With preinstalled geotextile membrane (600x600mm).
Caniveau avec grille largeur 40mm en différentes longueurs. Siphon démontable, filtre à cheveux. Avec membrane géotextile prémontée (600x600mm).

A good finish starts with the best choice

The new stainless steel gutter is narrower, aesthetically pleasing and aesthetically pleasing and robust. It is also easier to install easy to install in all kinds of situations, even in flat showers due to its 30 mm siphon option.





Tiled shower tray waste outlets
 Vidages pour plateaux de douche carrelés



Linum[®] Wall

One design for each installation.
 Une large gamme de designs adaptés à chaque installation.

Available covers:
 Caches disponibles:

Stainless steel cover with a fill-in frame
 Cadre de remplissage acier inox.

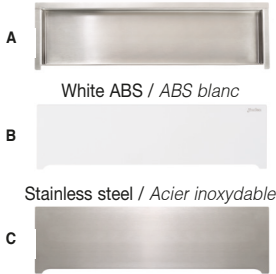

Outlet options: Options de sortie:



Lateral horizontal outlet 40F/50M to be glued. Sortie latérale horizontale 40F/50M à coller.	Lateral 45° orientable outlet PP male 40/50 mm. Sortie latérale 45° orientable PP mâle 40F/50M.	Frontal horizontal outlet 40F/50M to be glued. Sortie frontale horizontale 40F/50M à coller.	Frontal 45° orientable outlet PP male 40/50 mm. Sortie frontale 45° orientable PP mâle 40F/50M.
---	--	---	--

Whitout fabric
Sans film



Whit fabric
Avec film
3 + Code

Water seal height Hauteur siphon	Cover / Cache	Model	Code	Model	Code	Model	Code	Model	Code	€	*€
		Modèle		Modèle		Modèle		Modèle			
30 mm	A	S-860	014300	S-860	014303	S-861	014312	S-861	014315	367,08	382,10
	B	S-880	014301	S-880	014304	S-881	014313	S-881	014316	358,94	374,36
	C	S-890	014302	S-890	014305	S-891	014314	S-891	014317	362,18	378,01
50 mm	A	S-860	014306	S-860	014309	S-861	014318	S-861	014321	367,08	382,10
	B	S-880	014307	S-880	014310	S-881	014319	S-881	014322	358,94	374,36
	C	S-890	014308	S-890	014311	S-891	014320	S-891	014323	362,18	378,01

Accessible wall slot channel with detachable trap and hair filter.
 Caniveau mural avec registre. Siphon extractible filtre à cheveux.

*With geo-textile water tightening fabric 2x1,5 m. / Avec film d'étanchéité géotextile 2x1,5 m.



Visible frame
Cadre visible



Hidden frame
Cadre invisible



Tiled shower tray waste outlets
 Vidages pour plateaux de douche carrelés



Linum®

One design for each installation.
 Une large gamme de designs adaptés à chaque installation.

Slot channel for masonry built showers / Caniveau pour douche à l'italienne

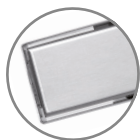

Hidden frame
 Cadre Invisible

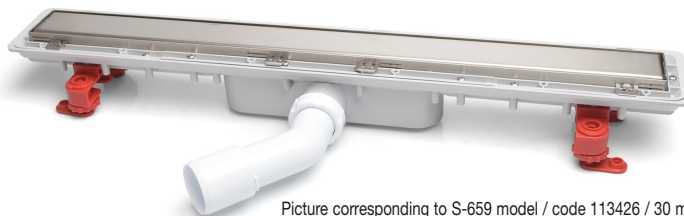

Picture corresponding to S-659 model / code 113426 / 30 mm water seal height
 Image correspondant au modèle S-659 / code 113426 / hauteur siphon 30 mm

		Soft				Classic					
Grid options: Options de grille:											
Outlet options: Options de sortie:											
		Horizontal outlet 40F/50M mm. Sortie horizontale 40F/50M mm.		45° swivelling outlet PP male 40/50 mm. Sortie 45° orientable PP male 40/50 mm.		Horizontal outlet 40F/50M mm. Sortie horizontale 40F/50M mm.		45° swivelling outlet PP male 40/50 mm. Sortie 45° orientable PP male 40/50 mm.		Whitout fabric Sans film + Whit fabric Avec film 3 + Ref.	
Water seal height Hauteur siphon	Long mm Longueur mm	Model Modèle	Code	Model Modèle	Code	Model Modèle	Code	Model Modèle	Code	€	*€
30 mm 	650	S-659	113446	S-659	113426	S-651	113416	S-651	113406	281,25	340,33
	750	S-659	113447	S-659	113427	S-651	113417	S-651	113407	301,91	365,31
	850	S-659	113448	S-659	113428	S-651	113418	S-651	113408	328,30	397,28
	950	S-659	113449	S-659	113429	S-651	113419	S-651	113409	354,74	429,26
50 mm 	350			S-759	113543			S-751	113513	250,62	
	550			S-759	113545			S-751	113515	265,93	
	650			S-759	113546			S-751	113516	281,26	371,27
	750			S-759	113547			S-751	113517	301,91	398,52
	850			S-759	113548			S-751	113520	328,32	
	950			S-759	113549			S-751	113519	354,74	

Reduced height
 Hauteur réduite

Slot channel with grid, width 50 mm, in different lengths and hidden frame. Detachable trap with anti vac device.
 Caniveau avec grille de largeur 50 mm en différentes longueurs et cadre invisible. Siphon extractible avec soupape d'aération.
 *With geo-textile water tightening fabric 2x1,5 m. / Avec film d'étanchéité géotextile 2x1,5 m.

		Supplied without grid / Grille non fournie				Whitout fabric Sans film
Water seal height Hauteur siphon	Long mm Longueur mm	Model Modèle	Code	Model Modèle	Code	€
30 mm 	650	S-650	113461	S-650	113460	325,18
	750	S-650	113471	S-650	113470	345,47
	850	S-650	113481	S-650	113480	372,84
	950	S-650	113491	S-650	113490	404,28
50 mm 	350			S-750	113531	295,12
	550			S-750	113551	310,14
	650			S-750	113561	325,18
	750			S-750	113571	345,47
	850			S-750	113581	372,84
	950			S-750	113591	404,28

Reduced height
 Hauteur réduite

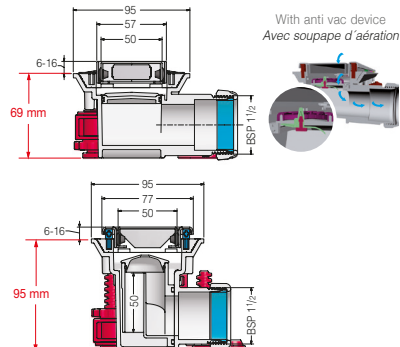

Tiled shower tray waste outlets

Vidages pour plateaux de douche carrelés



Linnum®

A wide range of designs adapted to each installation.
Une large gamme de designs adaptés à chaque installation.

Slot channel for masonry built showers / Caniveau pour douche à l'italienne

New Linnum model with reduced height, length 650, siphon height 30mm, both outlet versions, with waterproofing fabric, without frame or grille.

Nouveau modèle Linnum à hauteur réduite, longueur 650, hauteur siphon 30 mm, les deux versions de sortie, avec tissu imperméabilisant, sans cadre ni grille.

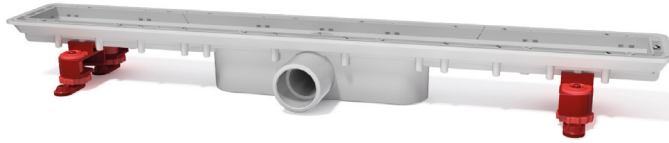

Horizontal outlet
40H/50M mm glue.
Sortie horizontale
40H/50Mmm colle.



45° adjustable PP male outlet
40/50mm.
Sortie mâle PP réglable à 45°
40/50mm.



Without/sans
cloth

With/avec cloth
3 + Ref

N

Altura Reducida

Height Hauteur	Length mm Long mm	Model	Code	Model	Code	€	€
30 mm	650	S-650	113410	S-650	113411	165,23	208,73

New model set of 650x50 hidden frame with soft cover in matte black finish.

Nouveau modèle d'ensemble de cadre caché 650x50 avec couverture souple en finition noir mat.



N

Length mm Long mm	Soft S-752	U/	€
650	013565N	1	131,21

Tiled shower tray waste outlets
 Vidages pour plateaux de douche carrelés



Linum®

One design for each installation.
 Une large gamme de designs adaptés à chaque installation.

Slot channel for masonry built showers / Caniveau pour douche à l'italienne



Visible frame
 Cadre visible

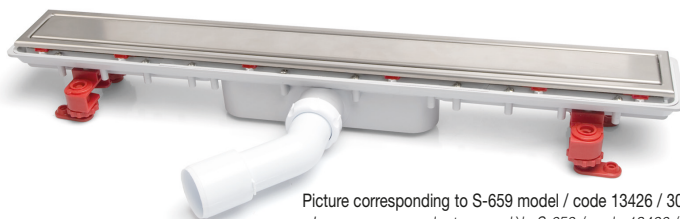

Picture corresponding to S-659 model / code 13426 / 30 mm water seal height
 Image correspondant au modèle S-659 / code 13426 / hauteur siphon 30 mm

		Soft				Classic						
Grid options: Options de grille:												
Outlet options: Options de sortie:												
		Horizontal outlet 40F/50M mm. Sortie horizontale 40F/50M mm.		45° swivelling outlet PP male 40/50 mm. Sortie 45° orientable PP male 40/50 mm.		Horizontal outlet 40F/50M mm. Sortie horizontale 40F/50M mm.		45° swivelling outlet PP male 40/50 mm. Sortie 45° orientable PP male 40/50 mm.		Whitout fabric Sans film		
Water seal height Hauteur siphon		Long mm Longueur mm	Model Modèle	Code	Model Modèle	Code	Model Modèle	Code	Model Modèle	Code	€	*€
30 mm 	650	S-659	013446	S-659	013426	S-651	013416	S-651	013406	255,69	281,25	
	750	S-659	013447	S-659	013427	S-651	013417	S-651	013407	274,48	301,91	
	850	S-659	013448	S-659	013428	S-651	013418	S-651	013408	298,47	328,30	
	950	S-659	013449	S-659	013429	S-651	013419	S-651	013409	322,51	354,74	
50 mm 	350			S-759	013543			S-751	013513	227,84		
	550			S-759	013545			S-751	013515	241,75		
	650			S-759	013546			S-751	013516	255,69	281,26	
	750			S-759	013547			S-751	013517	274,48	301,91	
	850			S-759	013548			S-751	013520	298,47	328,32	
	950			S-759	013549			S-751	013519	322,51	354,74	

Slot channel with grid, width 50 mm, in different lengths and visible frame. Detachable trap with anti vac device.
 Caniveau avec grille de largeur 50 mm en différentes longueurs et cadre visible. Siphon extractible avec soupape d'aération.

*With geo-textile water tightening fabric 2x1,5 m. / Avec film d'étanchéité géotextile 2x1,5 m.

		Supplied without grid / Grille non fournie				Whitout fabric Sans film	
Water seal height Hauteur siphon		Long mm Longueur mm	Model Modèle	Code	Model Modèle	Code	€
30 mm 	650	S-650	013461	S-650	013460	231,20	
	750	S-650	013471	S-650	013470	245,59	
	850	S-650	013481	S-650	013480	265,06	
	950	S-650	013491	S-650	013490	287,42	
50 mm 	350			S-750	013531	209,82	
	550			S-750	013551	220,51	
	650			S-750	013561	231,20	
	750			S-750	013571	245,59	
	850			S-750	013581	265,06	
	950			S-750	013591	287,42	

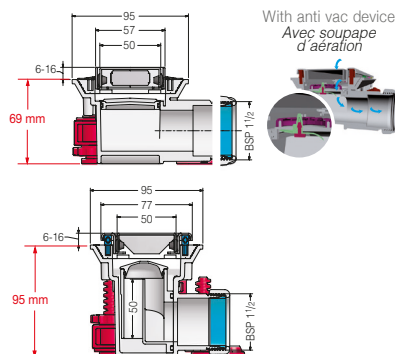

Tiled shower tray waste outlets
 Vidages pour plateaux de douche carrelés



Linum®

One design for each installation.
 Une large gamme de designs adaptés à chaque installation.

Slot channel for masonry built showers / Caniveau pour douche à l'italienne



Visible frame
 Cadre visible



Picture corresponding to S-771 model / code 13716 / 50 mm water seal height
 Image correspondant au modèle S-771 / code 13716 / hauteur siphon 50 mm

Grid options by model:
 Options de grille par modèle:

Soft



Classic



Outlet:
 Sortie:

Horizontal outlet PP 40F mm.
 Sortie horizontale PP 40F mm.

45° swivelling outlet PP male 40/50 mm.
 Sortie 45° orientable PP male 40/50 mm.

Whitout fabric
 Sans film

Whit fabric
 Avec film
 3 + Ref.

Water seal height Hauteur siphon	Long mm Longueur mm	Model Modèle	Code	Model Modèle	Code	€	*€
	350	S-779	013743	S-771	013713	227,84	
	550	S-779	013745	S-771	013715	241,75	
	650	S-779	013746	S-771	013716	255,69	281,26
	750	S-779	013747	S-771	013717	274,48	301,91
	850	S-779	013748	S-771	013718	298,47	328,32
	950	S-779	013749	S-771	013719	322,51	354,74

Slot channel with grid, width 70 mm, in different lengths and visible frame. Detachable trap.
 Caniveau avec grille de largeur 70 mm en différentes longueurs et cadre visible. Siphon extractible.
 *With geo-textile water tightening fabric 2x1,5 m. / Avec film d'étanchéité géotextile 2x1,5 m.

Supplied without grid / Grille non fournie				Whitout fabric Sans film
Water seal height Hauteur siphon	Long mm Longueur mm	Model Modèle	Code	€
	350	S-770	013731	209,82
	550	S-770	013751	220,51
	650	S-770	013761	231,20
	750	S-770	013771	245,59
	850	S-770	013781	265,06
	950	S-770	013791	287,42

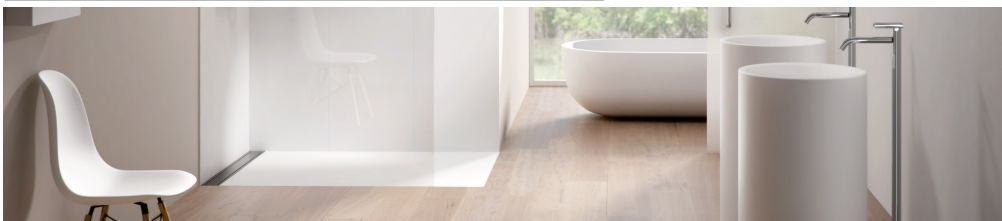
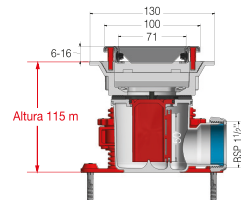

Tiled shower tray waste outlets

Vidages pour plateaux de douche carrelés



Linum®

Slot channel for masonry built showers / *Caniveau pour douche à l'italienne*

One design for each installation.
Une large gamme de designs adaptés à chaque installation.

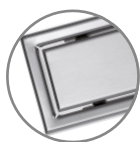

Visible frame
Cadre visible



Picture corresponding to S-771 model / code
Image correspondant au modèle S-771 / code

Soft

Grid options by model:

Options de grille par modèle:



Classic



Outlet:
Sortie:



Vertical outlet ABS 50M mm
Sortie verticale ABS 50M mm

Vertical outlet ABS 50M mm
Sortie verticale ABS 50M mm

Whitout fabric
Sans film

Long mm Longueur mm	Model Modèle	Code	Model Modèle	Code	€
350	S-779	013710	S-771	013722	193,65
550	S-779	013711	S-771	013724	205,49
650	S-779	013701	S-771	013714	217,34
750	S-779	013702	S-771	013720	233,31
850	S-779	013712	S-771	013732	253,70
950	S-779	013704	S-771	013721	274,14

Slot channel with grid, width 70 mm, in different lengths and visible frame.
Caniveau avec grille de largeur 70 mm en différentes longueurs et cadre visible.

Long mm Longueur mm	Supplied without grid / Grille non fournie		Whitout fabric Sans film
	Model Modèle	Code	€
350	S-770	013752	167,85
550	S-770	013753	176,41
650	S-770	013754	184,96
750	S-770	013762	196,47
850	S-770	013763	212,05
950	S-770	013764	229,94

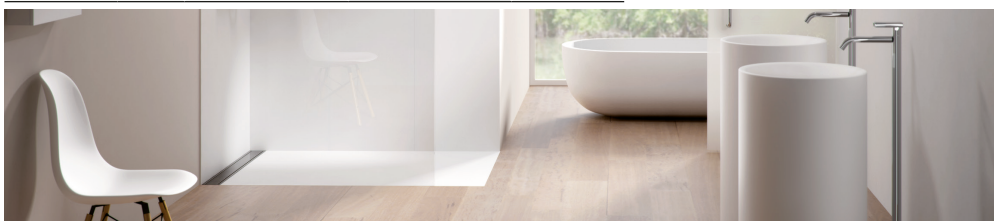
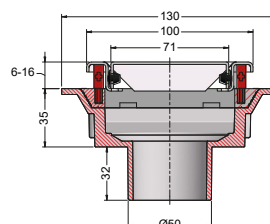

Tiled shower tray waste outlets

Vidages pour plateaux de douche carrelés

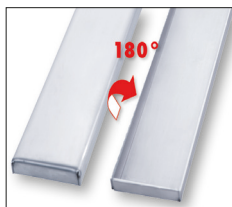

Custom finish / Finitions personnalisées

Thanks to its reversible design, Soft model, different finishes (ceramic, marble, glass) can be obtained. Simply by turning the grid 180° you will get a fill-in frame to match the bathroom design.

Grâce au design réversible du modèle Soft, il est facile d'y intégrer d'autres matériaux (céramique, marbre, pâte de verre...) Il suffit de retourner la grille à 180° pour obtenir un cadre de remplissage davantage en harmonie avec le reste de la pièce.



AVAILABLE GRIDS FOR S-750 AND S-650 SLOT CHANNEL / GRILLES DISPONIBLES POUR LE CANIVEAU S-750 ET S-650

S-650



S-750

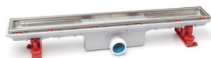

Grid options / Options de grille:

S-752 Soft



S-758 Classic



Long mm Longueur mm	Soft S-752	Classic S-758		€
350	013535	013532	1	56,54
550	013555	013552	1	59,34
650	013565	013562	1	62,19
750	013575	013572	1	67,87
850	013585	013582	1	71,23
950	013595	013592	1	74,09

Grid available in different lengths. Stamping cut.

Grille disponible en différentes longueurs. Découpe par emboutissage.



AVAILABLE GRIDS FOR S-770 SLOT CHANNEL / GRILLES DISPONIBLES POUR LE CANIVEAU S-770

S-770



S-772 Soft



S-773 Classic



Long mm Longueur mm	Soft S-772	Classic S-773		€
350	013735	013736	1	56,54
550	013755	013756	1	59,34
650	013765	013766	1	62,19
750	013775	013776	1	67,87
850	013785	013786	1	71,23
950	013795	013796	1	74,09

Grid available in different lengths. Stamping cut.

Grille disponible en différentes longueurs. Découpe par emboutissage.

Linnum®

Corner drain for brick shower tray.
 Drain d'angle pour receveur de douche en brique.

Grid options / Options de grille:

Cutting by stamping. / Découpe par emboutissage.

Soft



Square

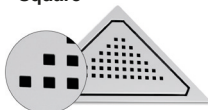

Outputs for models / Sorties pour les modèles:

S-790, S-791, S-794.



45° adjustable PP outlet
 male 40/50 mm.
 Sortie PP réglable à 45°
 mâle 40/50 mm.



Horizontal outlet
 40H mm glue.
 Sortie horizontale
 Colle 40H mm.

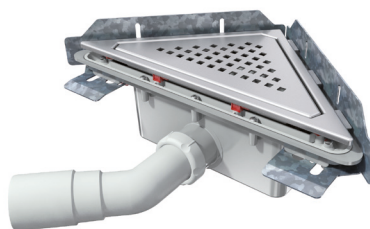
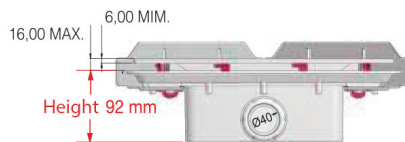

Output/Sortie	Soft S-790	Square S-791	U/	⊠n°.	€
1½" H / Ø40/50 elbow/courbe	13350	13352	1	A-8	164,07
Ø40 H To glue/Coller	13351	13353	1	A-8	164,07

Siphonic drain for built-in shower tray.

Bonde siphonique pour receveur de douche à encastrer.

Output/Sortie	Elegance S-794	U/	⊠n°.	€
1½" H / Ø40/50 elbow/courbe	13358	2	A-8	182,85
Ø40 H To glue/Coller	13359	2	A-8	182,85

Siphonic drain for built-in shower tray.

Bonde siphonique pour receveur de douche à encastrer.

TRIANGULAR SUMP GRILLES / GRILLES DE PUISARD TRIANGULAIRES

Soft S-790	Square S-791	U/	⊠n°.	€
013390	013391	1	A-10	37,64

Cutting by stamping.

Découpe par emboutissage.





Camaleon®

Extensible floor gully for tile shower stall plate
Siphon de sol extensible pour receveur de douche à carrelé

100 mm GRID 100 mm - WATER SEAL 50 mm / GRILLE 100 mm - SIPHON 50 mm 

Grid options and finishes:

Options de grille and finitions:

S-429 / S-629 S-430 / S-630

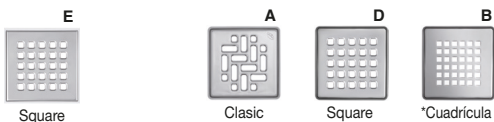

*Cut with a laser thickness 3 mm / découpées au laser. Epaisseur 3 mm



Satin-finish / Satiné



Chrome / Chromé

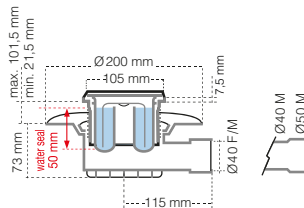

DRY TRAP KIT INCORPORATED
KIT SIPHON SEC INTÉGRÉ
Pag. 92.



Horizontal Horizontal
Horizontale Horizontale
40M / 40H 40M / 50M

S-429

Whitout fabric
Sans film

S-629

Horizontal Horizontal
Horizontale Horizontale
40M / 40H 40M / 50M

Fabric/Film 1,5X2m



Whit fabric
Avec film

Grid / Grille	Code	Code	€	Code	Code	€
Classic E Without frame/sans cadre - satin	012938	012958	4 A-9 61,53	012109	012132	1 - 106,47



Horizontal Horizontal
Horizontale Horizontale
40M / 40H 40M / 50M

S-430

Whitout fabric
Sans film

S-630

Horizontal Horizontal
Horizontale Horizontale
40M / 40H 40M / 50M

Fabric/Film 1,5X2m



Whit fabric
Avec film

Grid / Grille	Code	Code	€	Code	Code	€
Classic A - satin	012927	012937	4 A-9 64,58	012122	1 - 195,10	
Classic A - chrome	012948	012968	4 A-9 74,58	012110	012112	1 - 138,32
Cuadrícula B - satin		012975	4 A-9 136,44			
Cuadrícula B - chrome	012945	012965	4 A-9 108,50			
Square D - satin	012957	012977	4 A-9 64,58	012135	1 - 113,99	
Square D - chrome	012947	012967	4 A-9 74,58	012136	1 - 123,11	

Floor gully for masonry built shower tray, horizontal outlet. Stainless steel grid 98 x 98 mm

S-629 and S-630 models with geotextil watertightening fabric 2x1,5m.

Siphon de sol pour receveurs de douche à carrelé. Sortie horizontale. Grille en acier inoxydable 98 x 98 mm

Modèles S-629 et S-630 avec film d'étanchéité en PVC 2 x 1,5 m collé.

Camaleon Magnetech®

Extensible floor gully for tile shower stall plate
Siphon de sol extensible pour receveur de douche à carrelé

100 mm

GRID 100 mm - MAGNETIC LOCK / GRILLE 100 mm- FERMETURE MAGNÉTIQUE



Horizontal 40F
Horizontale 40F

S-592

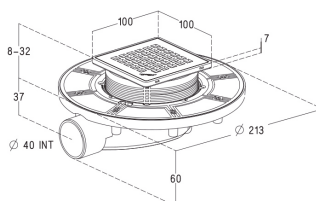

Whitout fabric
Sans film

Horizontal 40F
Horizontale 40F

S-593



Fabric/Film 1,5X2m

Whit fabric
Avec film

Grid / Grille	Code	€	Code	€
Square - satin	013643	4 - 79,11	013644	1 - 125,72

Compact floor gully for mansony built shower tray. Horizontal outlet 40 F. AISI 304 stainless steel 100x100 grid. S-593 model with geotextil watertightening fabric 2x1,5m.
Siphon de sol compact pour receveurs de douche à carrelé. Grille en acier inoxydable AISI 304 100x100. Modèle S-593 avec film d'étanchéité géotextile 2x1,5 m.



Horizontal 40F
Horizontale 40F

S-594

Whitout fabric
Sans film

Horizontal 40F
Horizontale 40F

S-595



Fabric/Film 1,5X2m

Whit fabric
Avec film

Grid / Grille	Code	€	Code	€
Soft - satin	013645	4 - 142,43	013646	1 - 189,02

Compact floor gully for mansony built shower tray. Horizontal outlet 40 F. AISI 304 stainless steel 100x100 fill-in frame. S-595 model with geotextil watertightening fabric 2x1,5m.
Siphon de sol compact pour receveurs de douche à carrelé. Cadre de remplissage en acier inoxydable AISI 304 100x100. Modèle S-595 avec film d'étanchéité géotextile 2x1,5 m.

CAMALEON MAGNETECH GRID FLOOR GULLY

GRILLE POUR SIPHON DE SOL CAMALEON MAGNETECH



Model Modèle	Code	Grid / Grille			€
Square (M)	031672	A - satin	-	-	49,69



Tiled shower tray waste outlets
Vidages pour plateaux de douche carrelés



Floor gully for masonry built shower tray combining reduced height and high performance (high flow rate and anti-odour trap) / Siphon de sol pour receveurs de douche à carrelé qui combine une faible hauteur et une haute performance (haut débit d'évacuation et siphon anti-odeurs)



The shower water exerts pressure on the moving part of the magnetic valve which opens to allow the flow. The higher is the water flow, the higher is the pressure.
L'eau de la douche exerce une pression sur la partie mobile du clapet magnétique qui s'ouvre pour permettre l'écoulement. Plus le débit d'eau augmente, plus la pression est importante et plus le clapet s'ouvre.



At the end of the shower, the water flows reduces and the magnetic force allows the valve to close. Zero dirt.
En fin de douche le débit d'eau se réduit et la force magnétique permet la fermeture du clapet. Zéro encrassement.



The magnetic force ensures the closure of the valve, which, combined with the 1cm water seal guarantees the absence of odours. It is 100% airtight.
STOP TO BAD ODOURS
La force magnétique assure la fermeture du clapet, ce qui, combiné avec le garde d'eau de 1 cm garantit l'absence d'odeurs. Il est 100% hermétique.
STOP AUX MAUVAISES ODEURS.

Design / Design

Available with grid and one fill-in version to integrate the floor gully installation in any kind of environment.
Disponible avec grille et une version de grille à carrelé disponibles pour permettre d'intégrer l'installation du sol dans n'importe quel espace douche.

Odour free / Sans odeurs

Its magnetic lock and its water seals prevent bad odours.
Sa fermeture magnétique et son garde d'eau évitent la remontée d'odeurs.



Dual trap / Siphon dual

Magnetic lock + 1cm water seal.
Fermeture magnétique + garde d'eau de 1 cm.

60 mm



Ultra-compact / Ultra-compact

To install a masonry built shower tray in reduced space.
Pour installer un receveur de douche à carrelé dans un espace réduit.

Easy access / Facile accès

Full access to the drain allowing the trap cleaning and maintenance. Load class K3.
Accès total à la canalisation pour permettre le nettoyage et entretien du siphon. Classe K3

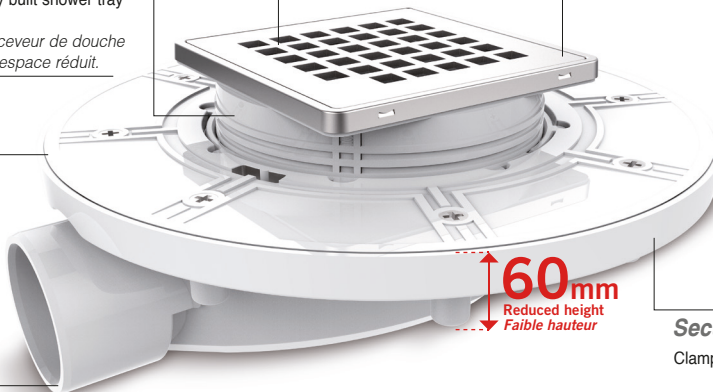

60mm
 Reduced height
 Faible hauteur



Security / Sécurité

Clamping set that ensures waterproofing.
Bague de serrage pour assurer l'imperméabilisation.



High flow rate

Haut débit d'évacuation
 Till 36 l/min. / Jusqu'à 36 l/min.





Camaleon®

Extensible floor gully for tile shower stall plate
Siphon de sol extensible pour receveur de douche à carrelé

120 mm GRID 120 mm - WATER SEAL 50 mm / GRILLE 120 mm - SIPHON 50 mm

Grid options and finishes:

Options de grille and finitions:

S-520 - S-522 - S-537

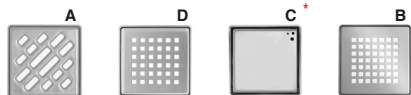

Camaleon 120 Square Soft *Cuadrícula

* (Cut with a laser thickness 3 mm / découpées au laser. Epaisseur 3 mm)



Satin-finish / Satiné



Chrome / Chromé

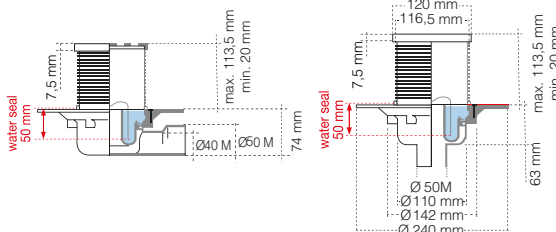

DRY TRAP KIT INCORPORATED
KIT SIPHON SEC INTÉGRÉ
Pag. 92.

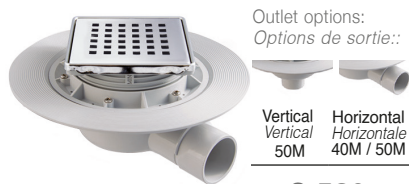

Outlet options:
Options de sortie:



Vertical 50M Horizontal 40M / 50M

S-520

Whitout fabric
Sans film

Outlet options:
Options de sortie:



Vertical 50M Horizontal 40M / 50M

S-522

Fabric/Film 1,5X2m



Whit fabric
Avec film

Grid / Grille	Code	Code	€	Code	Code	€
Camaleon 120 A - satin	013820	013821	4 A-13 74,36	013824	013825	1 - 136,62
Square D - satin	013900	013902	4 A-13 74,36	013904	013906	1 - 136,62
Square D - chrome	013901	013903	4 A-13 104,47	013905	013911	1 - 148,89
Cuadrícula B - satin	013826	013827	4 A-13 152,64			

Floor gully for shower tray works, horizontal or vertical PVC outlet. Stainless Steel grid 112 x 112 mm.

S-522 model and S-630 with geotextil watertightening fabric 2x1,5m.

Siphon de sol pour receveurs de douche à carrelé, sortie horizontale ou verticale. Grille en Acier inoxydable de 112 x 112 mm

Modèle S-522 avec film d'étanchéité en PVC 2 x 1.5 m collé.

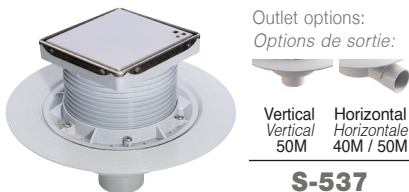

Outlet options:
Options de sortie:



Vertical 50M Horizontal 40M / 50M

S-537

Whitout fabric
Sans film

Grid / Grille	Code	Code	€
Soft C - satin	013844	013845	4 A-13 81,76

Floor gully for shower tray works, horizontal or vertical PVC outlet. Stainless Steel grid 112 x 112 mm.

Siphon de sol pour receveurs de douche à carrelé, sortie horizontale ou verticale. Grille en Acier inoxydable 112 x 112 mm.

* To convert to Soft, replace extensible part with 31419.
Pour convertir en Soft, remplacez l'extensible part par 31419.

Soft grid installation: Soft grid 120x120 allows the floor gully installation in any atmosphere.

Installation de la grille Soft. La grille soft 120x120 permet l'installation du siphon de sol dans toute sorte d'ambiance.

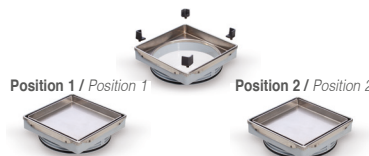

SOFT grids can be installed in an open position (1) or in a hidden position (2) to be filled with the same floor finishing. Les grilles SOFT peuvent être installées de façon apparente (position 1) ou encastrée (position 2) de façon à y intégrer la même finition que le reste du sol.



Camaleon®

Extensible floor gully for tile shower stall plate
 Siphon de sol extensible pour receveur de douche à carrelé

150 mm GRID 150 mm - WATER SEAL 50 mm / GRILLE 150 mm - SIPHON 50 mm

Grid options and finishes:
 Options de grille and finitions:

S-550 - S-551 - S-552

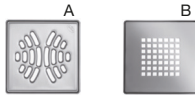

Camaleon 150 *Cuadrícula

* (Cut with a laser thickness 3 mm / découpées au laser. Epaisseur 3 mm)



Satin-finish / Satiné



Chrome / Chromé



DRY TRAP KIT INCORPORATED
 KIT SIPHON SEC INTÉGRÉ
 Pag. 92.

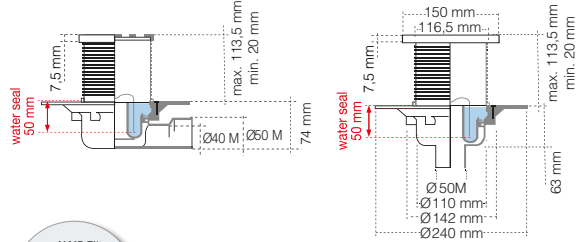

Outlet options:
 Options de sortie:

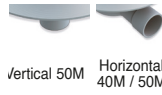

S-550

Outlet options:
 Options de sortie:

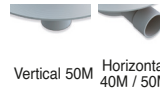

Whitout fabric
 Sans film

S-552



Whit fabric
 Avec film

Grid / Grille	Code	Code	€	Code	Code	€
Camaleon 120 A - satin	013850	013851	4 A-13 80,54		013855	1 - 143,20
Cuadrícula B - satin	013856	013857	4 A-13 178,07			
Cuadrícula B - chrome	013656	-	4 A-13 200,53			

Floor gully for masonry built shower tray. Vertical or horizontal outlet. Stainless Steel grid 142 x 142 mm.
 S-552 model and S-630 with geotextil watertightening fabric 2x1,5m.
 Siphon de sol pour receveur de douche à carrelé. Sortie verticale ou horizontale. Grille en Acier Inoxydable de 142 x 142 mm.
 Modèle S-552 avec film d'étanchéité en PVC 2 x 1,5 m collé.

ACCESSORIES / ACCESSOIRES

A-136

Code	€
1,5x1,5 m 022087 1 A-11	78,79
2x1,5 m 022274 1 A-11	94,79

PVC fabric, waterproofed. / Film d'étanchéité en PVC.

A-145

Code	€
2x1,5 m 022303 1 A-2	120,02

Geotextile fabric, waterproofed.
 Film d'étanchéité géotextile.

More water tightening fabrics on page 70. / Plus de films d'étanchéité page 70.

Tiled shower tray waste outlets Vidages pour plateaux de douche carrelés



The Camaleon 100, 120 and 150mm range is equipped with a dry siphon, which prevents the appearance of odors even if the hydraulic seal disappears.
La gamme Camaleon 100, 120 et 150mm est équipée d'un siphon sec, ce qui empêche l'apparition d'odeurs même si le joint hydraulique disparaît.

DRY TRAP KIT / KIT SIPHON SEC



Camaleon with DUAL system / Camaleon avec système DUAL



50 mm
Water seal height.
Hauteur siphon



O-ring in the raiser which enables a better adjustment and an easier installation.
Avec joint torique pour un meilleur ajustement pendant l'installation de la rallonge.



Double safety with its new dry trap system which prevents bad odours from coming out when water seal has disappeared.
Double sécurité avec son nouveau système de siphon sec qui évite que les mauvaises odeurs apparaissent lorsque la garde d'eau a disparu.



Remove infiltrated water by means of the integrated holes in the pressing ring.
Élimine l'eau infiltrée grâce aux orifices de drainage intégrés dans l'anneau de serrage.



Easy to remove Hair filter for cleaning.
Filtre à cheveux extractible pour un nettoyage facile.



Lead free PVC injected body
Corps du siphon de sol fabriqué en PVC sans plomb.

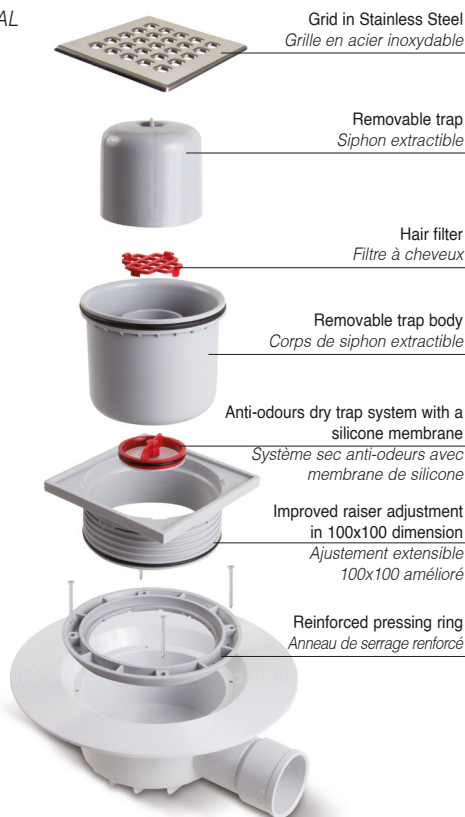
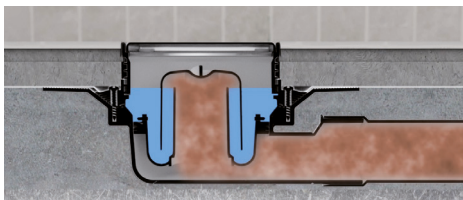
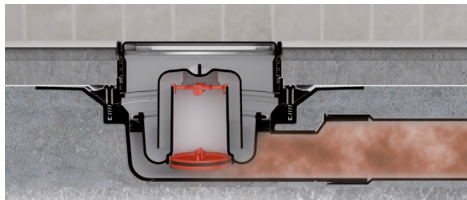

Image shown corresponds to S-429
L'image correspond au modèle S-429

New dry trap system which prevents bad odours / Nouveau système sec qui évite les mauvaises odeurs



Water drainage creates an hydraulic seal which prevents bad odours from the piping coming into the bathroom.
Le passage de l'eau forme une garde d'eau qui évite que les odeurs n'arrivent à l'intérieur des tuyaux de la salle de bains.



The valve prevents, even in case of hydraulic seal failure, bad odours from coming into the bathroom.
La bonde évite que les mauvaises odeurs arrivent jusqu'à la salle de bains même dans le cas où la garde d'eau disparaît.



camaleon plus

Floor gully range for vinyl floor finishing
 Gamme de siphons de sol pour sols à revêtement en vinyle

Grids/covers available:
 Grilles/capots disponibles:



S-598
 Cover ABS
 Capot ABS

S-599
 Cover stainless steel
 Capot acier inoxydable

S-399
 Grid ABS
 Grille ABS

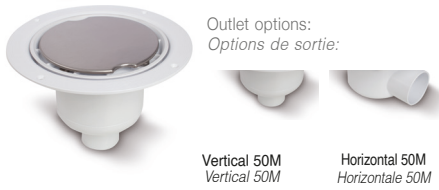
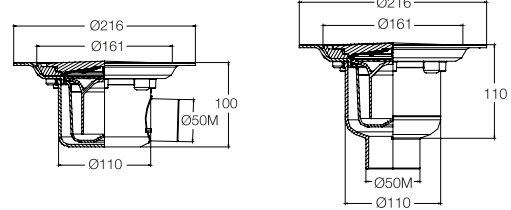

Outlet options:
 Options de sortie:

Vertical 50M
 Verticale 50M Horizontal 50M
 Horizontale 50M

Outlet options:
 Options de sortie:

Vertical 50M
 Verticale 50M Horizontal 50M
 Horizontale 50M

Cover / Capot

Grid / Grille

Grid / Grille	Model Modèle	Code	Model Modèle	Code	€	Model Modèle	Code	Model Modèle	Code	€		
White ABS / Blanc ABS	S-598	012451	S-598	012450	4 4120	91,36	S-399	012449	S-399	012448	4 4120	91,36
Ac. Inox. / Aço. Inox	S-599	012453	S-599	012452	4 4120	129,88						

