

WC - Toilet | WC - Toilette

Cisterns mechanisms | Mécanismes chasse d'eau

Turkish basin urinal traps | Siphons WC turcs

WC pan connectors | Pipes WC

Sanitary macerators and | Broyeurs et Station de
Lifting Station CICLON | Relevage Sanitaires CICLON



Sanitary

SANITARY





SANITARY

Cisterns mechanisms Mécanismes chasse d'eau



FLUSHING MECHANISMS / MÉCANISMES CHASSE D'EAU

New flushing mechanism 3g with **infrared actuator**.

Nouveau mécanisme de chasse 3g avec actionnement par **infrarouges**.



S-585

Color/Couleur	Code			€
Chrome	023488	10	-	106,78

Double volume flushing mechanism with infrared actuator (adaptable to the "Roca" base). Cistern kit (joint with screws) and threaded base not included. For cisterns with 40 mm push button diameter. Works with 4 LR6 batteries (not included).

Mécanisme de chasse double volume avec actionnement par infrarouges (adaptable à base "Roca"). Kit chasse d'eau (joint avec vis) et base fileté non fournis. Pour chasses d'eau à diamètre de 40mm. Fonctionne avec 4 piles LR6 (non incluses).



A-148

Color/Couleur	Code			€
Chrome	023489	10	-	71,60

Push button with infrared actuator for 3G mechanisms. Works with 4 LR6 batteries (not included). Allows manual flushing. With LED indicator.

Bouton poussoir avec actionnement par infrarouges. Fonctionne avec 4 piles LR6 (non incluses). Permet la décharge manuelle. Avec voyant LED.



More hygienic
Plus hygiénique



For intensive use
Pour usage intensif



Safe from bacteria and virus
À l'abri des bactéries et virus



Push button with infrared actuator. Allows manual flushing.
With LED indicator.

Bouton poussoir avec actionnement par infrarouges.
Permet décharge manuelle. Avec voyant LED.

Easy and quick installation.

Installation facile et rapide.

Adaptable:

Suitable for every position, vertical or horizontal.

Adaptável:

Peut être installer en position verticale ou horizontale.

Compact:

Fits in most of low tank cisterns.

Compact:

Peut-être installé dans la plupart des réservoirs bas.

Ecological:

Its multiple regulation options enable to reduce the water consumption up to 35m³/year.

Écologique:

Ses multiples options de réglage permettent de réduire la consommation d'eau jusqu'à 35m³/an

Robust:

Its reinforced body has been designed to assure many years of operation.

Robuste:

Son corps renforcé a été conçu pour assurer de longues années de fonctionnement.

Reliable:

Its sealing joint is compatible with the chemical agents contained in water and its soft close system enables an optimal performance in the long term.

Fiable:

Son joint de fermeture est compatible avec les agents chimiques présents dans l'eau et sa fermeture à effet amortisseur permet un fonctionnement optimal à long terme.

Universal:

Compatible with Roca basis.

Universel:

Compatible avec les bases Roca.



3g

S-576
 Color/Couleur Code €

Chrome	023308	20	A-12	36,31
--------	---------------	----	------	--------------

IN BAG / EN SACHET

Double volume flushing mechanism. Easy installation (adaptable to the "Roca" base). Threaded base included. Cistern kit (joint with screws) not included.
Mécanisme de chasse double volume. Facile à installer (adaptable à base "Roca"). Base filetée incluse. Kit chasse d'eau (joint avec vis) non inclus.

3g

S-585
 Color/Couleur Code €

Chrome	023387	10	A-8	41,30
--------	---------------	----	-----	--------------

Double volume flushing mechanism for easy installation (Adaptable to the "Roca" base). Includes cistern kit (connector with screws).
Mécanisme de chasse double volume facile à installer (Adaptable à la base "Roca"). Kit chasse d'eau (joint avec vis) livré.

New universal flushing mechanism.
2 volumes.
Nouveau mécanisme de chasse universel. 2 volumes.

S-584
 Color/Couleur Code €

Chrome	023487	20	A-9	27,77
--------	---------------	----	-----	--------------

Flushing mechanism 2L with threaded base. Cistern kit (joint with screws) not included.
Mécanisme chasse d'eau 2L avec base filetée. Kit chasse d'eau (joint avec vis) non inclus.



Easy and quick installation.
Installation facile et rapide.

Compact:
 Fits in most of low tank cisterns.
Compact:
Peut-être installé dans la plupart des réservoirs bas.

Ecological:
 Its multiple regulation options enable to reduce the water consumption up to 35m³/year.
Écologique:
Ses multiples options de réglage permettent de réduire la consommation d'eau jusqu'à 35m³/an.

Robust:
 Its reinforced body has been designed to assure many years of operation.
Robuste:
Son corps renforcé a été conçu pour assurer de longues années de fonctionnement.

Universal:
 Compatible with Roca basis.
Universel:
Compatible avec les bases Roca.





S-294

Color/Couleur	Code			€
Chrome	023102	25	A-12	19,78

Flushing mechanism with pull button (partial flush).
 Mécanisme de chasse avec cordon (déclenchement partiel).

FILLING MECHANISMS / ROBINETS FLOTTEURS

2g



S-465

	Code			€
3/8	023250	10	A-11	19,05
1/2	023260	10	A-11	19,05

Compact float valve, horizontal or vertical inlet (threaded brass).

Robinet flotteur compact alimentation latérale ou inférieure (anneau laiton).

2g



S-560

	Code			€
3/8	023300	10	A-8	20,10

Compact float valve, horizontal inlet (threaded brass).

Robinet flotteur compact alimentation latérale (anneau laiton).

The DUAL float valve can be adapted to every cistern. It enables the use of horizontal or vertical inlet with 3/8" brass threaded fitting and filter.

Le robinet flotteur DUAL peut s'adapter à n'importe quel réservoir. Il permet l'alimentation latérale ou inférieure avec l'utilisation de l'anneau en laiton de 3/8" et filtre.

Horizontal inlet

Screw the 3/8" fitting onto the horizontal inlet.

Alimentation latérale

Visser la prise d'alimentation 3/8" sur l'entrée latérale.



Float valve

Its height regulates the filling of the cistern tank.

Robinet flotteur

Sa hauteur règle le remplissage du réservoir.

3/8" inlet fitting

Equipped with an inlet filter. Suitable for vertical or horizontal installations.

Prise d'alimentation 3/8"

Equipped with a filter. Permits its installation in vertical or horizontal position.

Height adjustable

The height of the float valve can be adjusted for an easy adaptation to any kind of cisterns.

Réglable en hauteur

La hauteur du robinet flotteur peut être réglée s'adapter à n'importe quel type de réservoir.

Adjusting screw

Enables to regulate the filling of the cistern.

Vis de réglage

Permet de régler le remplissage du réservoir.

Vertical inlet

Screw the 3/8" fitting onto the vertical inlet if this is your case.

Alimentation inférieure

Visser la prise d'alimentation 3/8" sur l'entrée inférieure si il s'agit de votre cas.

Pressure range: 0,5 bar to 16 bar / gamme de pression: 0,5 bar à 16 bar

HIGH MOUNT CISTERNS / RÉSERVOIR SUSPENDU

S-47

	Code			€
1 1/4"	023016	10	A-13	36,51

High mount cistern, flushing valve, float valve, pull lever, 12 liters.
Réservoir suspendu, vanne de déclenchement, robinet flotteur, balancier déclencheur, 12 litres.

S-149

	Code			€
1 1/4"	023040	25	A-4	14,84

Flush mechanism set, including flushing valve, float valve, chain and lever.
Ensemble mécanisme chasse d'eau comprenant la vanne de déclenchement, le robinet flotteur, le balancier et le cordon.

S-147

	Code			€
-	023020	10	A-13	16,03

High mount cistern, 12 liters.
Réservoir suspendu, 12 litres.

S-165

	Code			€
1 1/4"	023050	10	A-5	32,81

High mount, small cistern, flushing valve, float valve, pull lever, 8 liters.
Petit Réservoir suspendu, vanne de déclenchement, robinet flotteur, balancier déclencheur, 8 litres.

S-171

	Code			€
-	023060	16	A-5	10,29

High mount, small cistern, 8 liters.
Petit Réservoir suspendu, 8 litres.

A-82

	d	h
Ø 32	25	25
Ø 40	38	28

	Code			€
Ø 65 x 25 <small>For Ø 32 tube / Pour tube Ø 32</small>	023130	20	A-10	6,03
Ø 65 x 38 <small>For Ø 40 tube / Pour tube Ø 40</small>	023131	20	A-10	6,03

Pipe joint connector to WC.
Joint de connexion du tube au WC.



SANITARY

Turkish basin urinal traps - WC pan connectors
Siphons WC turcs - Pipes WC





TURKISH BASIN URINAL TRAPS / SIPHONS WC TURCS

S-162  PVC

110	Code			€
	021010	5		47,20

Vertical outlet with adjustable direction.
Sortie verticale orientable.

S-166  PVC

110	Code			€
	021050	5	A-4	41,82



Vertical outlet with adjustable direction.
Sortie verticale orientable.

S-163  PVC

110	Code			€
	021020	5	A-4	47,20

Horizontal outlet.
Sortie horizontale.



S-172  PVC

110	Code			€
	021060	5	A-4	41,82

Horizontal outlet.
Sortie horizontale.



WC PAN CONNECTORS / PIPES WC

S-164  PVC

90	Code			€
	021030	25	A-12	9,80
110	021040	25	A-5	10,42



Pan connector. / Pipe WC.

S-391  PVC

110-25	Code			€
	021370	25	A-5	14,80



Eccentric PVC pan connector with multi-joint connector system.
Pipe WC PVC excentrées avec système multijoints.

S-213  PVC

90-25	Code			€
	021070	25	A-12	10,87
110-16	021170	25	A-5	11,91



Eccentric pan connector. / Pipe WC excentrée.

S-390  PVC

110	Code			€
	021360	25	A-5	13,93

PVC pan connector with multi-joint connector system.
Pipe WC toilettes PVC avec système joints multiples.

S-327  PVC

110x50	Code			€
	021190	10	A-13	39,00

Extendible bended pan connector with joint and 3 auxiliary inlets Ø 50 and reducer to Ø 40 mm.
Pipe coudée manchon toilettes coude avec joint et 3 prises auxiliaires Ø 50 et réduction à Ø 40 mm.





	Code			€
Ø110 - 45°	021220	18	A-12	11,47
Ø110 - 22°	021210	18	A-4	11,85
Ø90 - 90°	021231	20	-	19,26
Ø110 - 90°	021230	18	A-5	13,79

Pan connector with elbow (PP white).
Pipe WC coudée (PP blanc).



	Code			€
Ø110	021430	25	A-13	12,78

Long PP pan connector. / Pipe WC longue.

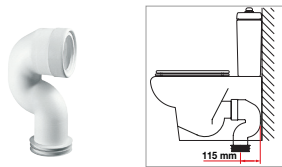

	Code			€
110-90°	021300	12	A-5	29,86

Banded pan connector, adjustable interior.
(For toilets with Dual outlet).
Pipe WC coudée, ajustable. (Pour toilettes avec sortie Dual).



	Code			€
110-90°	021390	12	A-5	26,42

Short, banded pan connector, adjustable interior.
(For toilets with Dual outlet).
Pipe WC coudée court, ajustable. (Pour toilettes avec sortie Dual).



	Code			€
110	021410	10	A-12	23,47
110	021420*	10	A-12	25,92
Fastening kit. Fixation kit.	031459	10	A-10	3,48

Banded pan connector, Dual outlet.
Pipe WC coudée, sortie Dual.

(* With fastening kit / Avec fixation kit)



	Code			€
110	021408	10	A-12	27,43
110	021409*	10	A-12	29,81
Tornillo / Parafuso	031459	10	A-10	2,86

Shortenable pan connector . Dual outlet.
Pipe WC coudée raccourcissable . Sortie Dual.
* With fastening fast kit. / * avec fixation kit.



	Code			€
110	021421	1	14,5x50x14,5	85,49

Vertical eccentric pan connector.
Pipe WC excentrées vertical.

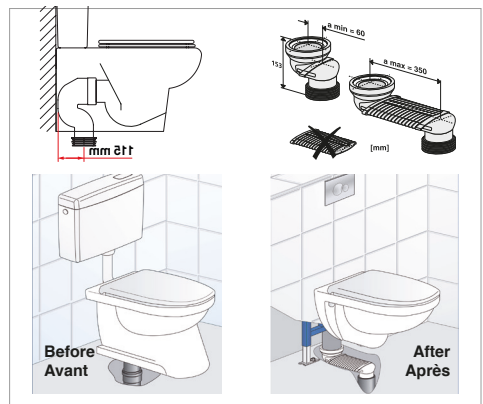

ELASTIC PAN CONNECTOR / PIPES WC ELASTIQUES



S-218

Ø 90
Ø 110

A **B** Ø 110

FLEXIBLE
FLEXIVEL

	Code			€	
A	90	021120	45	A-5	16,69
A	110	33017001	40	-	16,69
B	110	021090	45	A-5	13,66

Elastic pan connector.
Pipe WC élastique.



S-383

FLEXIBLE
FLEXIBLE

	Code			€	
	110-40	021270	36	A-5	16,60

Elastic pan connector for eccentric connections.
Pipe WC élastique excentrée.



S-219

Ø 90
Ø 110

A **B** Ø 110

FLEXIBLE
FLEXIVEL

	Code			€	
A	90-18	021130	45	A-5	16,69
A	110	33017021	30	-	16,69
B	110-16	021110	45	A-5	13,66

Elastic pan connector for eccentric connections.
Pipe WC élastique excentrée.



S-385

FLEXIBLE
FLEXIBLE

	Code			€	
	110-14°	021290	36	A-5	16,72

Bend, elastic pan connector.
Pipe WC élastique coudée.



S-384

FLEXIBLE
FLEXIBLE

	Code			€	
	110	021280	36	A-5	15,94

Long elastic pan connector.
Pipe WC élastique. longue.

New design
More adaptable
Nouveau design
Plus adaptable



S-500

FLEXIBLE
FLEXIBLE

	Code			€	
	110	021400	20	A-5	23,61

Extendable pan connector, for difficult to reach connections. Máx. 535 mm - Min. 225 mm.
Pipe WC extensible, pour connexions difficiles d'accès. Max. 535 mm - Min. 225 mm.



MKB2190

FLEXIBLE
FLEXIVEL

	Code			€	
	110	33017051	15	-	22,05

Elastic Pan connector, elbow 90°.
Pipe WC élastique coude 90°.



MKB3190

FLEXIBLE
FLEXIVEL

	Code			€	
	110	33017061	15	-	24,92

Elastic Pan connector, elbow - extra long 90°
Pipe WC élastique coude extra longue 90°.

MKB21104



FLEXIBLE
FLEXIVEL

110	Code	15	-	€
110	33017071	15	-	23,71

Elastic Pan connector, elbow 104°.
Pipe WC élastique coude 104°.

MKEA



FLEXIBLE
FLEXIVEL

110	Code	20	-	€
110	33017091	20	-	12,64

Extensible for pan connector.
Rallonge pour pipe WC.

SWIVELING PAN CONNECTOR / PIPE WC ORIENTABLE S-502

This pan connector allows different assembling positions for an optimal performance and in addition it is suitable for all the WCs on the market. Discover the most flexible quality solution for the WC.

Cette pipe WC permet plusieurs positions de montage pour une performance optimale et, en plus, elle est compatible avec tous les modèles de WCs du marché. Découvrez la solution de qualité la plus flexible pour le WC.



Fire resistance: VF ME class.

Résistance au feu: classe VF ME.

High leaktightness and security.

Grande étanchéité et sécurité.

Can be cut up to 130 mm.

Peut-être découpé jusqu'à 130 mm.

Available in two diameters: Ø90 and Ø110mm.

Disponible en deux diamètres: Ø90 et Ø110mm.

Can be solvent socket

Peut-être collée

Suitable for all the WCs in the market.

Compatible avec tous les WCs du marché.



Can rotate, or be used as a straight pan connector, elbowed or 45° angled.

Peut pivoter, être utilisé comme manchon droit, coudé ou manchon 45°.

S-502

90	Code	6	A-12	€
90	021411	6	A-12	52,22
110	021412	6	A-12	58,55



REPLACEMENT PARTS / PIÈCES DE RECHANGE
A-109

	Colour Couleur	Code			€
110	White Blanc	021350	10	A-1	6,71
110	Black Noir	021351	10	A-1	6,71

Junta para manguitos inodoro rígidos de 90.

Vedação para calção sanita PVC de 90.



	Code			€
ø 90-110	031117	10	A-1	8,63
Black pan connector joint. / Joint pipe WC noir.				
ø 110	031245	10	A-1	7,80
White pan connector joint (for S-328). / Joint pipe WC blanc (pour S-328).				
-	031163	10	A-2	14,16
Turkish basin trap joint / Joint siphon WC turcs.				
-	031199	5	A-1	10,86
Turkish basin trap joint / Joint siphon WC turcs.				
ø 90-110	031255	10	A-1	8,09
White pan connector joint(for S-344). / Joint pipe WC blanc (pour S-344).				

FEATURES / CARACTÉRISTIQUES

MATERIALS

- Body: EVA copolymer
 - Sealing gasket: Synthetic elastomer
- Adaptability: for low tank toilet or high with horizontal or vertical outlet

MATÉRIAUX

- Corps: EVA
 - Joint d'étanchéité: Elastomère synthétique sintético
- Adaptabilité: pour les WC à réservoir bas ou haut avec sortie horizontale ou verticale.

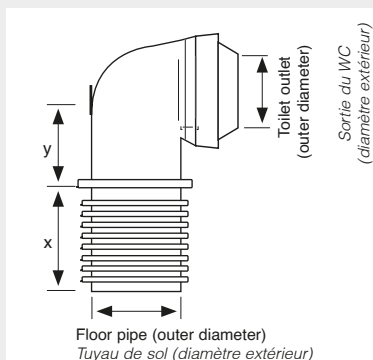

RULES OF USE

JOINING SYSTEMS

The principle of all connections is the formation of watertight joints created by multiple elastomer plastic tabs which are compressed against the downpipe and the toilet outlet.

INSTALLATION

Watertight union without need to use a lubricant.

The inside of the downpipe should be reasonably clean and smooth.

Insert the pan connector firmly inside the downpipe, align the toilet outlet with the mouth of the pan connector and push through the joint tabs.

For a total tightness, make sure that the tabs are fold inwards (figure 1)

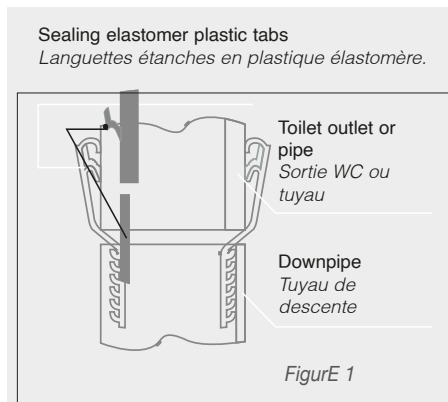

RÈGLES D'UTILISATION

SYSTÈMES DE RACCORDEMENT

Le principe de toutes les connexions est la formation de joints étanches créés par plusieurs languettes en plastique élastomère, qui se compriment contre le tuyau de descente et la sortie du WC.

INSTALLATION

Union étanche sans besoin d'utiliser un lubrifiant.

L'intérieur du tuyau de descente doit être raisonnablement propre et lisse.

Insérez fermement la pipe WC à l'intérieur du tuyau de descente, alignez la sortie du WC avec la bouche de la pipe WC et poussez à travers les languettes de joint.

Pour une étanchéité totale, il faut s'assurer que les languettes sont repliées vers l'intérieur (figure 1).

IMPORTANT

Do not use any lubricant. If necessary you can make the tabs more flexible immersing them in hot water at a maximum of 60°C.

Pan connectors should not be in contact with mineral oil, grease, sealant or any other compound containing mineral oil or grease. They must also be protected from direct rays of sun and fire.

IMPORTANT

Il ne faut utiliser aucun lubrifiant. Si nécessaire les languettes peuvent être rendues plus flexibles en les immergeant dans de l'eau chaude à 60°C.

Les pipes WC ne doivent pas entrer en contact avec de l'huile minérale, graisse, mastic ou tout autre composé contenant de l'huile ou de la graisse minérale, ils doivent également être protégés des rayons directs du soleil et du feu.





SANITARY

Sanitary macerators and Lifting Station CICLON Broyeurs et Station de Relevage Sanitaires CICLON



A complete range of products adapted to all needs.
Une gamme complète de produits adaptée à tous les besoins.

WC macerators with WC inlet and auxiliary inlets (Ø40mm). Vertical outlet 32 mm. Equipped with non return valve. Easy maintenance Cassette system. Quiet

Broyeurs sanitaires avec entrée pour WC et branchements auxiliaires (Ø40mm). Sortie verticale 32 mm. Equipés de clapet anti-retour. Système cassette de facile entretien. Silencieux.

Certificaciones / certificações:



1 WC inlet . 2 lateral inlets (Ø40mm). Motor: 550 W. Pumps up to 6 m vertical run or 62 m horizontal run.

1 Entrée pour WC. 2 branchements latéraux (Ø40mm). Moteur: 550W. Impulsion jusqu'à 6m en vertical ou 62 en horizontal.

CICLON L 6m ↑

T-604

Color/Couleur	Code			€
	075013	1	-	966,64



1 WC inlet. 1 right lateral inlet (Ø40mm). Motor: 470 W. Pumps up to 5 m vertical run or 52 m horizontal run.

1 Entrée pour WC. 1 branchement latéral droit (Ø40mm). Moteur: 470W. Impulsion jusqu'à 5m en vertical ou 52 en horizontal.

CICLON XS 5m ↑

T-502

Color/Couleur	Code			€
	075313	1	-	731,79



1 WC inlet. Motor: 470 W. Pumps up to 5 m vertical run or 52 m horizontal run.

1 Entrée pour WC. Moteur: 470W. Impulsion jusqu'à 5m en vertical ou 52 en horizontal.

CICLON FIT 1 5m ↑

T-501

Color/Couleur	Code			€
	075713	1	-	663,00



1 WC inlet. 1 lateral inlet (Ø40mm). Motor: 470 W. Pumps up to 5 m vertical run or 52 m horizontal run.

1 Entrée pour WC. 1 branchement latéral (Ø40mm). Moteur: 470W. Impulsion jusqu'à 5m en vertical ou 52 en horizontal.

CICLON FIT 2 5m ↑

T-502

Color/Couleur	Code			€
	075613	1	-	743,82



1 WC inlet . 2 lateral inlets (Ø40mm). Motor: 470 W. Pumps up to 5 m vertical run or 52 m horizontal run.

1 Entrée pour WC. 2 branchements latéraux (Ø40mm). Moteur: 470W. Impulsion jusqu'à 5m en vertical ou 52 en horizontal.

CICLON FIT 3 5m ↑

T-503

Color/Couleur	Code			€
	075513	1	-	888,94

Sanitary macerators and Lifting Station CICLON

Broyeurs et Station de Relevage Sanitaires CICLON



Lifting station Equipped with non return valve. Vertical outlet 32 mm. Easy maintenance Cassette system. Motor: 390 W. Pumps up to 7m vertical run or 72 m horizontal run. Quiet.

Station de relevage équipée de clapet anti-retour. Sortie verticale 32 mm. Système cassette de facile entretien. Moteur : 390 W. Impulsion jusqu'à 7 m en vertical ou 72 m en horizontal. Silencieuse.



3 lateral inlets (Ø40mm).
2 top inlets (Ø40mm includes valve to connect sanitary or house hold appliances)
Motor: 390 W. Pumps up to 7 m vertical run or 72 m horizontal run.

3 branchements latéraux (Ø40mm).
2 branchements supérieurs (Ø40mm inclus clapet pour la connexion d'appareils sanitaires ou électroménagers). Moteur : 390 W. Impulsion jusqu'à 7 m en vertical ou 72 m en horizontal.

CICLON^{LS} 7m ↑

EB-705

Color/Couleur	Code			€
	075413	1	-	712,01



Sanitary macerator to be concealed. CICLON CS

Broyeur sanitaire CICLON CS

Equipped with a non return valve. 32 mm vertical outlet. Easy maintenance cassette system. Motor:470 W. Pumps up to 6 m vertical run or 62 m horizontal run. Quiet.

Broyeur sanitaire pour encastrer. Equipé de clapet anti-retour. Sortie verticale 32 mm. Avec système cassette de facile entretien. Moteur: 470 W. Impulsion jusqu'à 6 m en vertical ou 62 m en horizontal. Silencieux.



Vertical pump: Up to 6 m.

Horizontal pump: Up to 62 m (with a 1% slope).

Inlets: 1 front, WC. 2 Ø40 mm side (shower, bidet, washbasin). 1 Ø40 mm top (washbasin).

Outlet: Ø32 mm PVC. (Ø28 or Ø22 mm with adapter).

Maximum admissible waste water temperature: 50° C.

Electrical supply: 220-240 V / 50 Hz.

Motor consumption: 470 W.

Take into account in the installation, a frontal registration for maintenance access (not included).

Évacuation verticale: jusqu'à 6 m.

Horizontale: Jusqu'à 62 m (avec une pente de 1%).

Entrées: 1 Latérale (WC) 2 latérales diam.40 mm (douche, bidet ou lavabo). 1 supérieure diam.40 mm (lavabo).

Sortie: diam 32 mm PVC (diam.28 ou 22 avec adaptateur).

Température admissible d' eau évacuée: 50°C

Alimentation électrique: 220-240 V/50 Hz

Consommation moteur: 470 W

Dans l' installation prévoir un registre frontal d' accès pour entretien (non inclus)

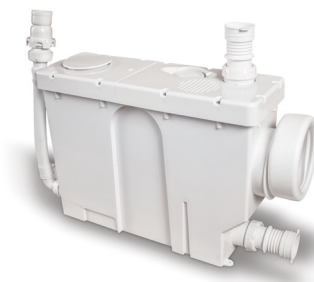

T-604 CS

6m ↑

Color/Couleur	Code			€
-	075813	1	-	949,79

Sanitary macerators and Lifting Station CICLON

Broyeurs et Station de Relevage Sanitaires CICLON



Concealed cistern with incorporated sanitary macerator

Réservoir bâti-support avec broyeur sanitaire incorporé



Cistern frame, 1125 mm height, 130 mm depth. Cable operated. Double adjustable flush (7,5 - 4,5 liters max or 4-2 liters min. For small operating plates (not included). Adjustable height from finished floor (0-200 mm).

Concealed macerator: PP body, fast coupling connections. Cassette system fully accessible.

Réservoir bâti-support, 1125 mm de haut, profondeur 130mm. Système d' actionnement par câble. Décharge double réglable (7,5 - 4,5 litres max ou 4-2 litres min). Pour plaques de commande de petit registre (non incluses). Hauteur au sol réglable (0-200 mm).

Broyeur encastré: Corps en PP. Connexions branchement rapide. Système cassette totalement accessible.

Vertical pump: Up to 6 m.

Horizontal pump: Up to 52 m (with a 1% slope).

Inlets: 1 front, WC. 2 Ø40 mm side (shower, bidet, washbasin). 1 Ø40 mm top (washbasin).

Outlet: Ø32 mm PVC.

(Ø28 or Ø22 mm with adapter).

Maximum admissible waste water temperature: 50° C.

Electrical supply: 220-240 V / 50 Hz.

Motor consumption: 470 W.

Évacuation verticale: Jusqu' à 6 mètres.

Évacuation horizontale: Jusqu' à 52 mètres (avec une pente de 1%).

Entrées: 1 frontale (WC), 2 latérales diam. 40mm (douche, bidet, lavabo). 1 supérieure diam.40 mm (lavabo).

Sortie: diam.32mm PVC (diam.28 ou 22 mm avec adaptateur).

Température maximale admissible d' eau évacuée: 50°C.

Alimentation électrique: 220-240V / 50 Hz

Consommation moteur: 470 W



T-604 CC

6m ↑



Color/Couleur	Code			€
-	075913	1	-	1.338,63

Concealed cistern with incorporated sanitary macerator. For small operating plates (not included). With mould for frontal register access to the motor with light wall (register not included).

Réservoir bâti-support avec broyeur sanitaire incorporé. Pour plaques de commande de petit registre (non incluses). Avec moule pour réaliser le registre frontal d' accès au moteur avec mur léger (registre non inclus).



T-604 CC

6m ↑



Color/Couleur	Code			€
White / Blanc	075914	1	-	2.199,18
Black / Noir	075915	1	-	2.199,18

Concealed cistern with incorporated sanitary macerator. With frontal cover in tempered glass to facilitate the register of the device.

Réservoir bâti-support avec broyeur sanitaire incorporé. Avec plaque frontale de recouvrement en verre trempé pour faciliter le registre de l' unité.

Sanitary macerators and Lifting Station CICLON

Broyeurs et Station de Relevage Sanitaires CICLON

