



15

TARIFA
PRICE LIST
ED.30 | 12.2015





Estimado Cliente:

Dear Customer:

En la presente Tarifa de Precios tiene a su disposición la nueva gama Interbath 2015/16.

At this Price List we are pleased to introduce the new products new range Interbath 2015/6.

Un documento que incluye, pensando siempre en las últimas tendencias del mercado, soluciones indispensables para hacer del cuarto de baño un espacio más confortable, atractivo, seguro y accesible.

A document that includes, always thinking of the latest market trends, essential solutions to make the bathroom a more comfortable, attractive, safe and accessible space.

Para ampliar o solicitar más información diríjase a nuestro Departamento de Ventas Nacional:

If you wish any further information, you can contact our International Sales Department:

 91 590 28 30

 oficina.centro@jimten.com

 www.interbath.es

 + 34 96 510 80 53

 international@jimten.com

 www.interbath.es

Quedamos a su disposición, participándoles un Cordial Saludo.

Thank you for your time and attention.
Yours faithfully,

JIMTEN, S/A



INTERBATH / INTERBATH

10 - 91

- Mangos / Handshowers**
- Columnas y rociadores / Columns and overheads**
- Soportes / Supports**
- Flexibles / Shower hoses**
- Barras de cortina y accesorios / Curtain rods and accessories**
- Menaje / Household ware**
- Ayudas para el baño / Bathroom aids**
- Jardín / Garden**



FONTANERÍA / PLUMBING PRODUCTS

92 - 108

- Lavabo - bidé / Washbasin - bidet**
- Fregadero / Sink**
- Plato de ducha / Shower tray**
- Accesorios / Accessories**
- Cisterna / Cistern**



INTERBATH BOLSA / INTERBATH IN BAG

109 - 122

- Mangos de ducha / Handshowers**
- Difusores / Shower heads**
- Barras murales / Slide bars**
- Flexibles / Shower hoses**
- Soportes para mango / Handshower supports**
- Accesorios / Accessories**



GRANEL / BULK PRODUCTS

123 - 129

- Mangos de ducha / Handshowers**
- Difusores / Shower heads**
- Barras murales / Slide bars**
- Soportes y accesorios / Supports and accessories**
- Flexibles / Shower hoses**
- Barras de cortina / Curtain rods**
- Menaje / Household ware**



MERCHANDISING / MERCHANDISING

130 - 134

- Expositores para productos / Product displays**
- Plan de disposición de mercancía / Merchandising layout plan**

ÍNDICE POR NÚMERO DE REFERENCIA / REFERENCE NUMBER INDEX 135

NORMAS GENERALES / GENERAL NORMS 138

CERTIFICADOS / CERTIFICATES 140

WEB 141



Lluvia / Rain

Ducha equipada con una función que proporciona una difusión del agua uniforme y suave por todo el cuerpo.

Shower equipped with a gentle uniform spray diffusion system to cover the whole body.



Stop / Stop

Ducha equipada con un dispositivo que permite detener el flujo de agua.

Shower equipped with a device that stops the water flow.



Masaje / Massage

Ducha equipada con una función que proporciona un fuerte y vigoroso masaje.

Shower equipped with a strong energizing massaging spray system.



Lluvia + Masaje / Rain + Massage

Combinación de las funciones de lluvia y masaje.

Combination of the rain and massage functions.



Espuma / Foam

Ducha suave con efecto espumoso mezcla de agua y aire, caudal abundante y menos consumo real.

Skillful smooth with frothy effect mixture of water and air, abundant volume and less real consumption.



Lluvia + Espuma / Rain + Foam

Combinación de las funciones de lluvia y espuma.

Combination of the rain and foam functions.



Bruma / Mist

Ducha suave con efecto aireado y refrescante y bajo consumo de agua.

Shower with soft airy and refreshing effect and low water consumption.



Lluvia + Bruma / Rain + Mist

Combinación de las funciones de lluvia y bruma.

Combination of the rain and mist functions.



Cascada / Waterfall

Ducha equipada con una función tipo cascada de agua que proporciona una agradable sensación de relajación y bienestar.

Shower equipped with a waterfall diffusion system to cover the whole body with a relaxing a wellness sensation.



Bruma + Masaje / Massage + Mist

Combinación de las funciones de masaje y bruma.

Combination of the massage and Mist functions.



Lluvia eco / Eco rain

Función que economiza hasta un 50% del consumo de agua con respecto a la función de lluvia normal, sin sensación de reducción del caudal.

Function that reduces up to 50% of the water consumption with respect to the normal rain function, without sensation of reduction of the volume.system to cover the whole body.



Diámetro / Diameter

Indica la superficie del área de rociado.
Indicates the surface of the rain area.



Diámetro / Diameter

Indica el diámetro exterior del tubo.
Indicates the external diameter of the tube.



Ahorro de agua / Water saver

Incluye un dispositivo reductor de flujo de agua que reduce el consumo de agua aproximadamente en un 50%. Esto supone un ahorro de agua medio de 73.000 litros anuales*.

* Cálculo realizado sobre una familia de 4 miembros.

Includes a water saver device which reduces the water consumption up to approximately 50%. This represents a water average of 73,000 liters per year.*

* Calculated on a 4 members family.



Filtro anti-impurezas / Dirtblocking filter

Junta filtro que alojada entre el flexible y el mango, evita la entrada de residuos en su mecanismo interno mejorando su funcionamiento y alargando así la vida del producto.

Filter Joint that placed between the filter and flexible hose, avoids the entry of waste into its internal mechanism improving its performance and longer product life. remainders into the handshower mechanism.



Luz Led / Led Light

Incluye una dinamo que activa 3 diferentes colores que cambian en función de la temperatura del agua.

Includes a dynamo device that activates 3 different colours depending on water temperature.



Medidas del Envase / Package sizes

Indica las dimensiones de la unidad de venta.
Indicates the size of the sales unit.



Membrana antical / Anti-lime membrane

Permite eliminar fácilmente las adherencias calcáreas presionando con el dedo sobre la membrana del difusor.

Offers an easy solution to the limescale problem by simply pressing the fingertip on the membrane of the diffuser the water flow.



Reforzado / Reinforced

Flexible (metálico o plástico) con mayor resistencia a la tracción mecánica.

Flexible (metal or plastic) more resistant to mechanical traction.



Material / Material

Indica el material en el que está fabricado el tubo.

Indicates the material in which the tube is manufactured.



Nuevo / New

Producto que se incorpora por primera vez a nuestra gama o que ha sido modificado desde la última Tarifa de Precios.

Product added to our range, or that has been modified since the last Interbath Price-List.the water flow.



Mangos / Handshowers

Cascada / <i>Waterfall function</i>	10
Masaje / <i>Massage</i>	12
Luz Led / <i>Led light</i>	32
Minimalistas / <i>Minimalist</i>	34
Gran diámetro / <i>Big diameter</i>	35
Antical / <i>Anti-lime</i>	45
Lluvia / <i>Rain</i>	51

Columnas y rociadores / Columns and rain overheads

Columnas de ducha / <i>Shower columns</i>	58
Rociadores / <i>Overheads</i>	64
Brazos de ducha y difusores / <i>Shower arms and shower heads</i>	66
Difusores / <i>Shower heads</i>	67

Soportes / Supports

Barras murales / <i>Slide bars</i>	68
Soportes para mango / <i>Handshower supports</i>	69

Flexibles / Shower hoses

Metálicos / <i>Metallic shower hoses</i>	71
Plásticos / <i>Plastic shower hoses</i>	72

Barras de cortina y accesorios / Curtain rods and accessories

Barras de cortina / <i>Curtain rods</i>	73
Rieles y accesorios / <i>Curtain rails and accessories</i>	77

Menaje / Household ware

78

Gama de ayudas para el baño / Bathroom aids

Asideros / <i>Grab bars</i>	80
Asientos para baño / <i>Seats for bathroom</i>	86
Asientos para WC / <i>WC toilet seats</i>	90

Jardín / Garden

Línea de riego con goteros integrados / <i>Irrigation line with integrated drips</i>	91
--	----

Masaje / Massage

4 FUNCIONES / 4 FUNCTIONS

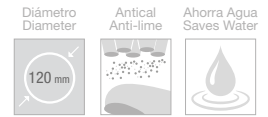
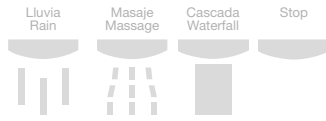

Vanity

Mango de ducha de masaje de 4 funciones y gran diámetro. Selector antideslizante. Permite pasar fácilmente de una función a otra. Incluye membrana anticalcárea. Nueva función CASCADA, con salida de agua tipo cortina que proporciona una agradable sensación de relajación y bienestar. Incluye función stop que permite detener la salida de agua. Fabricado en ABS cromado. Diámetro del difusor: 12 cm. Longitud: 24,4 cm.

Big diameter 4 functions handshower. Its anti-lime system offers an easy solution to the fimescafe problem by simply pressing the fingertip on the membrane of the diffuser. Antiskid selector ring facilitates the selection of the functions. Includes new WATERFALL function which provides a pleasant feeling of refaxation and wellness. Includes a stop function that stops the waterflow. Made in chromed ABS. Overhead diameter: 12 cm. Length: 24,4 cm.

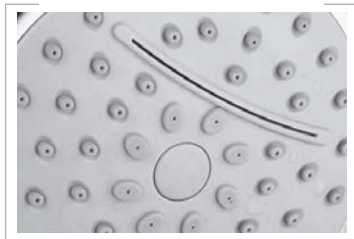

Vanity

Cod. Barras / Bar Code	Ref.	Color / Colour	U/	
8410787030091	08730014	○	4	27,30€

Mango de 4 funciones - Anticalcáreo - Gran diámetro ø12 cm.
4 functions handshower - Anti-lime system - Big diameter ø12 cm.

Blister: 150 x 290 x 65 mm



Combi Vanity

Cod. Barras / Bar Code	Ref.	Color / Colour	U/ 
8410787030114	09047314	○	2 34,67€

Mango de 4 funciones - Flexible metálico extensible hasta 2 m - Soporte Superform - Kit de tacos y tornillos.

4 functions handshower - Metallic shower hose extensible up to 2 m - Superform handshower support - Kit of screws and plugs.

 Blister: 220 x 290 x 80 mm



Variant Vanity

Cod. Barras / Bar Code	Ref.	Color / Colour	U/ 
8410787030107	09037314	○	2 59,01€

Mango de 4 funciones - Flexible metálico extensible hasta 2 m - Barra Practika 75 cm Ø 20 mm - Kit de tacos y tornillos.

4 functions handshower - Metallic shower hose extensible up to 2 m - Practika slide bar: 75 cm Ø 20 mm - Kit of screws and plugs.

 Blister: 235 x 830 x 70 mm



Masaje / Massage

5 FUNCIONES / 5 FUNCTIONS

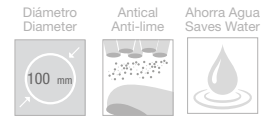
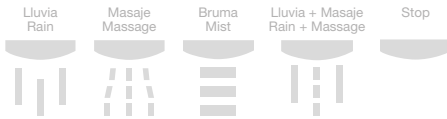

Fox Five

Mango de ducha de masaje de 5 funciones. Fabricado en ABS. Bajo consumo de agua. El sistema antical permite eliminar fácilmente las adherencias calcáreas presionando con el dedo sobre la membrana que incorpora el difusor. Su selector antideslizante permite pasar cómodamente de una función a otra. Incluye función nebulizada (Bruma). Área de rociado: Ø 100 mm. Longitud 23,5 cm.

5 functions massage handshower. Saves water. Its anti-lime system offers an easy solution to the limescale problem by simply pressing the fingertip on the membrane of the diffuser. Antiskid selector ring facilitates the selection of the functions. Includes Mist function. Rain area Ø 100 mm. Length 23,5 cm.



Fox Five

Cod. Barras / Bar Code	Ref.	Color / Colour	U/
8410787034556	08790014	○	4 17,90€

Mango de 5 funciones - Anticalcáreo - Ahorra agua - Selector antideslizante.

5 functions handshower - Anti-lime system - Saves water - Antiskid selector ring.

Blister: 150 x 290 x 65 mm





Combi Fox Five

Cod. Barras / Bar Code	Ref.	Color / Colour	U/ 
8410787034563	09047914	○	2

27,62€

Mango de 5 funciones - Flexible metálico extensible hasta 2 m - soporte Superform - Kit de tacos y tornillos.

5 functions handshower - Metallic shower hose extensible up to 2 m - Superform handshower support - Kit of screws and plugs.

 Blister: 220 x 290 x 80 mm

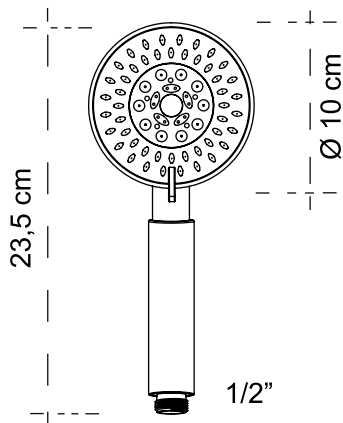

Masaje / Massage

3 FUNCIONES / 3 FUNCTIONS



Shine

Mango de ducha de masaje de 3 funciones. Fabricado en ABS. El sistema antical permite eliminar fácilmente las adherencias calcáreas presionando con el dedo sobre la membrana que incorpora el difusor. Ducha equipada de un botón PUSH para la rápida selección de sus funciones. Área de rociado: Ø 120 mm. Longitud 25 cm. **Bajo consumo de agua: Lluvia: 7,2 lit/min, Lluvia+masaje:10,8 lit/min, masaje: 6 lit/min.**

3 functions massage handshower. Its anti-lime system offers an easy solution to the limescale problem by simply pressing the fingertip on the membrane of the diffuser. Shower equipped with a PUSH button for a quick functions selection. Rain area Ø 120 mm. Length 25 cm. **Low water consumption: Rain: 7.2 lit/min, Rain+massage:10.8 lit/min, massage: 6 lit/min.**

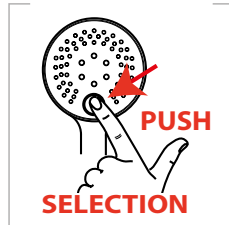

Shine

Cod. Barras / Bar Code	Ref.	Color / Colour	UI
8410787034723	08850014	○	4 24,62€

Mango de 3 funciones - Anticalcáreo - Ahorra agua - Push selección.

3 functions handshower - Anti-lime system - Saves water - Push selection

Blister: 150 x 290 x 65 mm





Combi Shine

Cod. Barras / Bar Code	Ref.	Color / Colour	U/ 
8410787034730	09048514		2 34,13€

Mango de 3 funciones - Flexible metálico extensible hasta 2 m - soporte Superform - Kit de tacos y tornillos.

3 functions handshower - Metallic shower hose extensible up to 2 m - Superform handshower support - Kit of screws and plugs.

 Blister: 220 x 290 x 80 mm

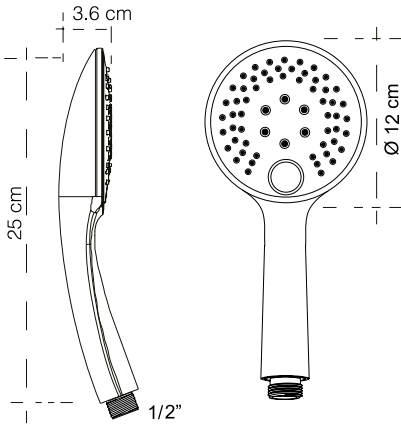

Masaje / Massage

4 FUNCIONES / 4 FUNCTIONS

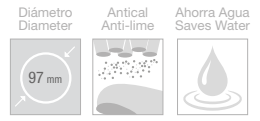
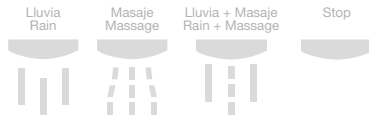

Party

Mango de ducha de masaje de 4 funciones. Anticalcáreo. Selector antideslizante. Permite pasar fácilmente de una función a otra. Incluye función stop que permite detener la salida de agua. Fabricado en ABS cromado. Diámetro del difusor: 9,7 cm. Longitud: 23,3 cm.

4 functions handshower. Anti-lime system. Antiskid selector ring that facilitates the selection of the functions. Includes a stop function that stops the water flow. Made in chromed ABS. Overhead diameter: 9,7 cm. Length: 23,3 cm.



Party

Cod. Barras / Bar Code	Ref.	Color / Colour	U/ 	
8410787030374	08740014		4	20,00 €

Mango de 4 funciones - Anticalcáreo - Ahorra Agua - Función Stop.
4 functions handshower - Anti-lime system - Saves water - Stop Button

Blister: 150 x 290 x 65 mm



Combi Party

Cod. Barras / Bar Code	Ref.	Color / Colour	U/ 
8410787030381	09047414	○	2 26,25 €

Mango de **4 funciones** - Flexible metálico extensible hasta 2 m - Soporte Superform - Kit de tacos y tornillos.

4 functions handshower - Metallic shower hose extensible up to 2 m - Superform handshower support - Kit of screws and plugs.

 Blister: 220 x 290 x 80 mm

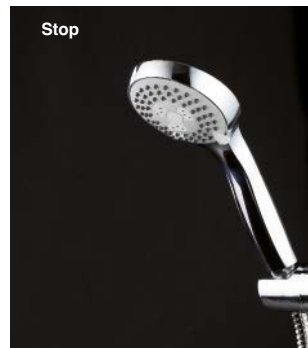
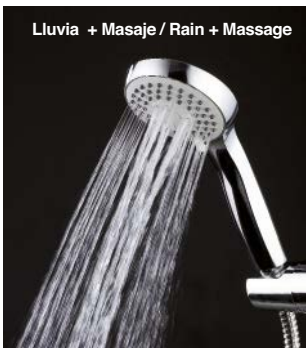
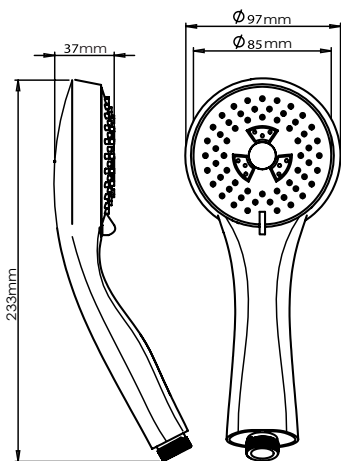

Masaje / Massage

3 FUNCIONES / 3 FUNCTIONS

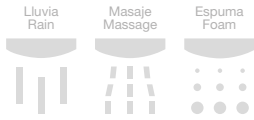

Holiday

Mango de ducha de gran diámetro. 3 funciones con membrana anticalcárea. Fabricado en ABS cromado. Diámetro del difusor: 12 cm. Longitud: 24 cm.

3 functions big diameter handshower with anti-lime membrane. Made in chromed ABS. Overhead diameter: 12 cm. Length: 24 cm.



Holiday

Cod. Barras / Bar Code	Ref.	Color / Colour	U/
8410787028623	08710014	○	4 20.95€

Mango de 3 funciones - Anticalcáreo - Ahorra agua - Incluye junta filtro anti-impurezas - Gran diámetro Ø 12 cm.

3 functions handshower - Anti-lime system - Saves water - Dirtblocking filter joint included - Big diameter Ø 12 cm.

Blister: 150 x 290 x 65 mm



Combi Holiday

Cod. Barras / Bar Code	Ref.	Color / Colour	U/ 
8410787028654	09047114	○	2 ^{31,97€}

Mango de 2 funciones - Flexible metálico extensible hasta 2 m - Soporte Superform - Kit de tacos y tornillos.

2 functions handshower - Metallic shower hose extensible up to 2 m - Superform handshower support - Kit of screws and plugs.

 Blister: 220 x 290 x 80 mm



Variant Holiday

Cod. Barras / Bar Code	Ref.	Color / Colour	U/ 
8410787028647	09037114	○	2 ^{58,49€}

Mango de 2 funciones - Flexible metálico extensible hasta 2 m - Barra Practika 75 cm Ø 20 mm - Kit de tacos y tornillos.

2 functions handshower - Metallic shower hose extensible up to 2 m - Practika slide bar: 75 cm Ø 20 mm - Kit of screws and plugs.

 Blister: 235 x 830 x 70 mm

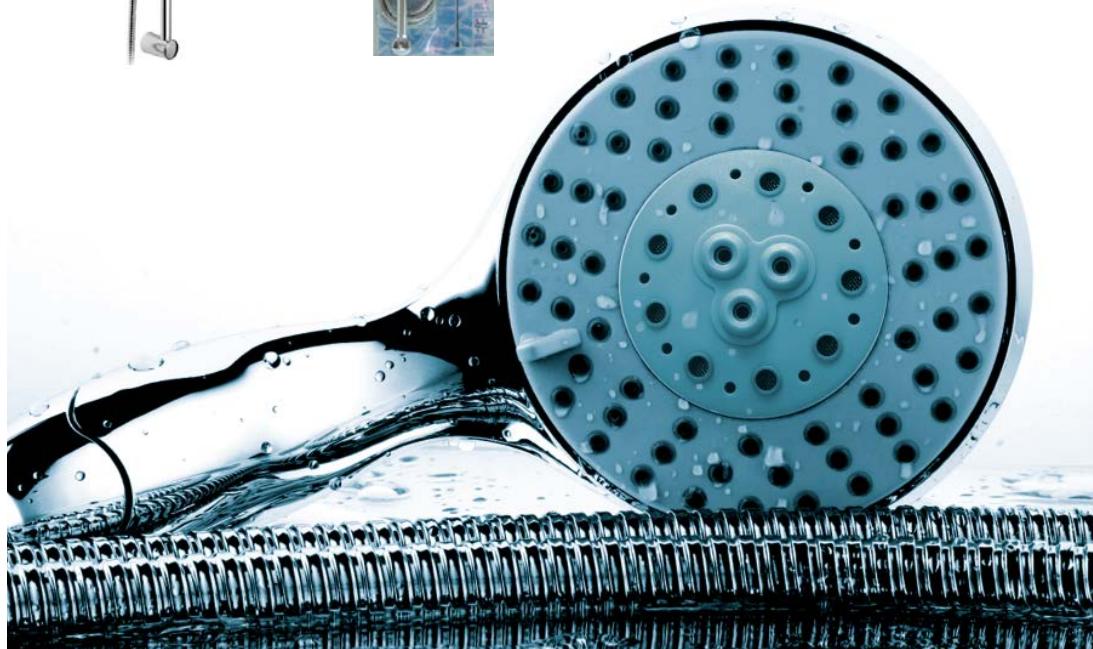

Masaje / Massage

2 FUNCIONES / 2 FUNCTIONS

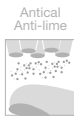

EcoWhite 2F

Mango de ducha de 2 funciones, lluvia y masaje. Bajo consumo de agua. Fabricado en ABS. El sistema antical permite eliminar fácilmente adherencias calcáreas presionando con el dedo sobre la membrana que incorpora el difusor. Su selector antideslizante permite pasar cómodamente de una función a otra. Area del rociador Ø105 mm, longitud 25 cm.

2 functions massage handshower, Rain and massage. Saves water. Its anti-lime system offers an easy solution to the limescale problem by simply pressing the fingertip on the membrane of the diffuser. Antiskid selector ring facilitates the selection of the functions. Rain area Ø 105 mm. Length 25 cm.



EcoWhite 2F

Cod. Barras / Bar Code	Ref.	Color / Colour	U/	Price
8410787034648	08840017	○	4	19,90€

Mango de 2 funciones - Anticalcáreo - Ahorra agua - Incluye junta filtro anti-impurezas - Gran diámetro Ø 10,5 cm.

2 functions handshower - Anti-lime system - Saves water - Dirtblocking filter joint included - Big diameter Ø 10,5 cm.

Blister: 150 x 290 x 65 mm



Combi EcoWhite 2F

Cod. Barras / Bar Code	Ref.	Color / Colour	U/
8410787034662	09048417		2 31,45€

Mango de 2 funciones - Flexible metálico extensible hasta 2 m - Soporte Superform - Kit de tacos y tornillos.

2 functions handshower - Metallic shower hose extensible up to 2 m - Superform handshower support - Kit of screws and plugs.

Blister: 220 x 290 x 80 mm



Variant EcoWhite 2F

Cod. Barras / Bar Code	Ref.	Color / Colour	U/
8410787034686	09058417		2 56,65€

Mango de 2 funciones - Flexible metálico extensible hasta 2 m - Barra Practika 75 cm Ø 20 mm - Kit de tacos y tornillos.

2 functions handshower - Metallic shower hose extensible up to 2 m - Practika slide bar: 75 cm Ø 20 mm - Kit of screws and plugs.

Blister: 235 x 830 x 70 mm



DUCHAS QUE LE AYUDAN A AHORRAR AGUA / SHOWER THAT HELPS SAVING WATER

EcoWhite 2F



20

EcoWhite 1F



40

Rociador/Overhead



65

Masaje / Massage

6 FUNCIONES / 6 FUNCTIONS



Luxor Plus

Mango de ducha de masaje de 6 funciones. Incorpora un dispositivo limitador de flujo de agua que reduce el consumo aproximadamente un 50%. El sistema antical permite eliminar fácilmente las adherencias calcáreas presionando con el dedo sobre la membrana que incorpora el difusor. Su selector antideslizante permite pasar cómodamente de una función a otra, además las diferentes funciones aparecen serigrafadas en el difusor. Incluye un filtro anti-impurezas que, alojado entre el flexible y el mango, evita la entrada de residuos en su mecanismo interno.

6 functions massage handshower. Includes a water saver device which reduces the water consumption up to approximately 50%. Its anti-lime system offers an easy solution to the limescale problem by simply pressing the fingertip on the membrane of the diffuser. Antiskid selector ring facilitates the selection of the functions. The different functions appear printed by serigraphy on the diffuser. A dirtblocking filter placed between the handshower and the shower hose avoids the incomings of any remainders into the handshower mechanism.



Luxor Plus

Cod. Barras / Bar Code	Ref.	Color / Colour	U/
8410787019225	08170102	○	2 23,57€
8410787019232	08170114	○	2 29,21€

Mango de 6 funciones - Anticalcáreo - Ahorra agua - Selector antideslizante serigrafado - Incluye junta filtro anti-impurezas.

6 functions handshower - Anti-lime system - Saves water - Antiskid selector ring with printed by serigraphy diffuser - Dirtblocking filter joint included.

Blister: 220 x 290 x 80 mm



Combi Luxor Plus

Cod. Barras / Bar Code	Ref.	Color / Colour	U/ 
8410787024113	09043514	○	2 36,22€

Mango de **6 funciones** - Flexible metálico extensible hasta 2 m - Soporte Superform - Kit de tacos y tornillos.

6 functions handshower - Metallic shower hose extensible up to 2 m - Superform handshower support - Kit of screws and plugs.

 Blister: 220 x 290 x 80 mm



Masaje / Massage

6 FUNCIONES / 6 FUNCTIONS

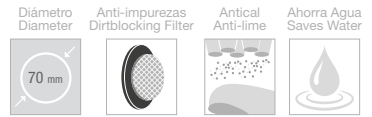
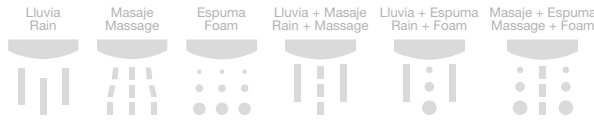

Turbobath • Relax

Mangos de ducha de masaje de 6 funciones. Incorporan un dispositivo limitador de flujo de agua que reduce el consumo aproximadamente un 50%. El sistema antical permite eliminar fácilmente las adherencias calcáreas presionando con el dedo sobre la membrana del difusor. Incluyen un filtro anti-impurezas que, alojado entre el flexible y el mango, evita la entrada de residuos en su mecanismo interno. Turbobath incorpora una turbina que aumenta la potencia del masaje.

6 functions massage handshowers. Include a water saver device which reduces the water consumption up to approximately 50%. Its anti-lime system offers an easy solution to the limescale problem by simply pressing the fingertip on the membrane of the diffuser. A dirtblocking filter placed between the handshower and the shower hose avoids the incomings of any remainders into the handshower mechanism. Turbobath includes a rotary turbine.



Turbobath - Relax

Cod. Barras / Bar Code	Ref.	Color / Colour	U/
8410787007741	08060002	○	6 13,07€
8410787007758	08060014	○	6 17,42€

Mango de 6 funciones - Anticalcáreo - Ahorra agua - Incluye junta filtro anti-impurezas.

6 functions handshower - Anti-lime system - Saves water - Dirtblocking filter joint included.

Blister: 112 x 290 x 80 mm



CONJUNTOS / SHOWER SETS

Combi Relax

Cod. Barras / Bar Code	Ref.	Color / Colour	U/
8410787019140	09043614	○	4 24,09€

Mango de 6 funciones - Flexible metálico extensible hasta 2 m - Soporte Superform - Kit de tacos y tornillos.

6 functions handshower - Metallic shower hose extensible up to 2 m - Superform handshower support - Kit of screws and plugs.

Blister: 220 x 290 x 70 mm



Variant Relax

Cod. Barras / Bar Code	Ref.	Color / Colour	U/
8410787019157	09033614	○	2 37,16€

Mango de 6 funciones - Flexible metálico extensible hasta 2 m - Barra Excalibur 60 cm Ø 20 mm - Kit de tacos y tornillos.

6 functions handshower - Metallic shower hose extensible up to 2 m - Excalibur slide bar: 60 cm Ø 20 mm - Kit of screws and plugs.

Blister: 193 x 705 x 70 mm



Masaje / Massage

6 FUNCIONES / 6 FUNCTIONS

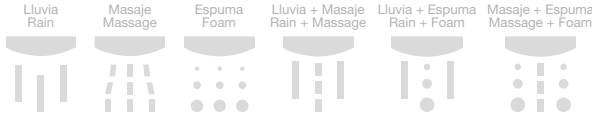

Total

Mangos de ducha de masaje de 6 funciones. Incorporan un dispositivo limitador de flujo de agua que reduce el consumo aproximadamente un 50%. El sistema antical permite eliminar fácilmente las adherencias calcáreas presionando con el dedo sobre la membrana del difusor. Incluyen un filtro anti-impurezas que, alojado entre el flexible y el mango, evita la entrada de residuos en su mecanismo interno. Turbobath incorpora una turbina que aumenta la potencia del masaje.

6 functions massage handshowers. Include a water saver device which reduces the water consumption up to approximately 50%. Its anti-lime system offers an easy solution to the limescale problem by simply pressing the fingertip on the membrane of the diffuser. A dirtblocking filter placed between the handshower and the shower hose avoids the incomings of any remainders into the handshower mechanism. Turbobath includes a rotary turbine.



Total

Cod. Barras / Bar Code	Ref.	Color / Colour	U/
8410787013094	08250002	○	6 11,79€
8410787013100	08250014	○	6 15,48€

Mango de 6 funciones - Anticalcáreo - Ahorra agua - Incluye junta filtro anti-impurezas.

6 functions handshower - Anti-lime system - Saves water - Dirtblocking filter joint included.

Blister: 112 x 290 x 80 mm

CONJUNTOS / SHOWER SETS

Combi Total Basic

Cod. Barras / Bar Code	Ref.	Color / Colour	U/
8410787033474	09062514	○	4 23,37€

Mango de 6 funciones - Flexible metálico extensible hasta 2 m - Soporte Practik - Kit de tacos y tornillos.

6 functions handshower - Metallic shower hose extensible up to 2 m - Practik handshower support - Kit of screws and plugs.

Blister: 220 x 290 x 70 mm



Variant Total Basic

Cod. Barras / Bar Code	Ref.	Color / Colour	U/
8410787033467	09052514	○	2 57,40€

Mango de 6 funciones - Flexible metálico extensible hasta 2 m - Barra Practika 75 cm Ø 20 mm - Kit de tacos y tornillos.

6 functions handshower - Metallic shower hose extensible up to 2 m - Practika slide bar: 75 cm Ø 20 mm - Kit of screws and plugs.

Blister: 235 x 830 x 70 mm



Masaje / Massage

3 FUNCIONES / 3 FUNCTIONS

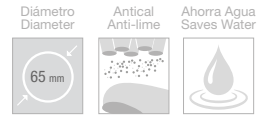
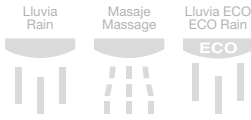

Testa



Testa

Cod. Barras / Bar Code	Ref.	Color / Colour	U/
8410787023901	08450002	○	6 11,38€
8410787023918	08450014	○	6 14,94€

Mango de 3 funciones - Anticalcáreo - Función lluvia eco - Selector antideslizante serigrafiado.

3 functions handshower - Anti-lime system - Eco rain - Antiskid selector ring with printed by serigraphy diffuser.

Blister: 112 x 290 x 70 mm

CONJUNTOS / SHOWER SETS



Combi Testa

Cod. Barras / Bar Code	Ref.	Color / Colour	U/
8410787023987	09044502	○	4 22,59€
8410787023994	09044514	○	4 24,22€

Mango de 3 funciones - Cromado: Flexible metálico extensible hasta 2 m - Blanco: Flexible de plástico de 2 m - Soporte Superform - Kit de tacos y tornillos.

3 functions handshower - Chrome: Metallic shower hose extensible up to 2 m - White: plastic shower hose: 2 m - Superform handshower support - Kit of screws and plugs.

Blister: 220 x 290 x 70 mm



Variant Testa

Cod. Barras / Bar Code	Ref.	Color / Colour	U/
8410787023949	09034502	○	2 31,00€
8410787023956	09034514	○	2 33,71€

Mango de 3 funciones - Cromado: Flexible metálico extensible hasta 2 m - Blanco: Flexible de plástico de 2 m - Barra Excalibur 60 cm Ø 20 mm - Kit de tacos y tornillos.

3 functions handshower - Chrome: Metallic shower hose extensible up to 2 m - White: plastic shower hose: 2 m - Excalibur slide bar: 60 cm Ø 20 mm - Kit of screws and plugs.

Blister: 193 x 705 x 70 mm

Masaje / Massage

3 FUNCIONES / 3 FUNCTIONS

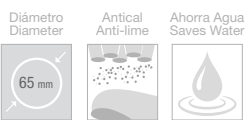

Prisma

Prisma

Cod. Barras / Bar Code	Ref.	Color / Colour	U/
8410787023888	08430002	○	6 11,38€
8410787023895	08430014	○	6 14,94€

Mango de 3 funciones - Anticalcáreo - Función lluvia eco - Selector antideslizante serigrafiado.

3 functions handshower - Antiskid selector ring - Eco rain - with printed by serigraphy diffuser.

Blister: 112 x 290 x 70 mm



CONJUNTOS / SHOWER SETS



Combi Prisma

Cod. Barras / Bar Code	Ref.	Color / Colour	U/
8410787023963	09044302	○	4 22,59€
8410787023970	09044314	○	4 24,22€

Mango de 3 funciones - Cromado: Flexible metálico extensible hasta 2 m - Blanco: Flexible de plástico de 2 m - Soporte Superform - Kit de tacos y tornillos.

3 functions handshower - Chrome: Metallic shower hose extensible up to 2 m - White: plastic shower hose: 2 m - Superform handshower support - Kit of screws and plugs.

Blister: 220 x 290 x 70 mm



Variant Prisma

Cod. Barras / Bar Code	Ref.	Color / Colour	U/
8410787023925	09034302	○	2 30,85€
8410787023932	09034314	○	2 33,71€

Mango de 3 funciones - Cromado: Flexible metálico extensible hasta 2 m - Blanco: Flexible de plástico de 2 m - Barra Excalibur 60 cm Ø 20 mm - Kit de tacos y tornillos.

3 functions handshower - Chrome: Metallic shower hose extensible up to 2 m - White: plastic shower hose: 2 m - Excalibur slide bar: 60 cm Ø 20 mm - Kit of screws and plugs.

Blister: 193 x 705 x 70 mm

Masaje / Massage

3 FUNCIONES / 3 FUNCTIONS

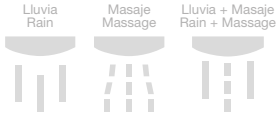

Niagara

Mango de ducha de masaje de 3 funciones. Incorpora un dispositivo limitador de flujo de agua que reduce el consumo aproximadamente en un 50%. Su selector antideslizante permite pasar fácilmente de una función a otra.

3 functions massage handshower. Includes a water saver device which reduces de water consumption up to approximately 50%. Its antiskid selector ring facilitates the selection of the functions.



Niagara

Cod. Barras / Bar Code	Ref.	Color / Colour	U/
8410787020863	08350002	○	6 11,04€
8410787020887	08350014	○	6 14,49€

Mango de 3 funciones - Selector antideslizante - Ahorra agua.
3 functions handshower - Saves water - Antiskid selector ring.

Blister: 112 x 290 x 70 mm



Combi Niagara

Cod. Barras / Bar Code	Ref.	Color / Colour	U/
8410787021242	09045202	○	4 17,54€
8410787021259	09045214	○	4 22,62€

Mango de 3 funciones - Flexible de plástico de 1,75 m - Soptero Superform - Kit de tacos y tornillos.

3 functions handshower - Plastic shower hose: 1,75 m - Superform handshower - Kit of screws and plugs.

Blister: 220 x 290 x 70 mm

Masaje / Massage

3 FUNCIONES / 3 FUNCTIONS

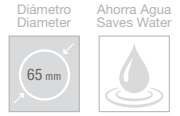
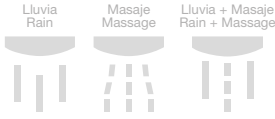

Symbol

Mango de ducha de masaje de 3 funciones. Incorpora un dispositivo limitador de flujo de agua que reduce el consumo aproximadamente en un 50%. Su selector antideslizante permite pasar fácilmente de una función a otra.

3 functions massage handshower. Includes a water saver device which reduces de water consumption up to approximately 50%. Its antiskid selector ring facilitates the selection of the functions.



Symbol

Cod. Barras / Bar Code	Ref.	Color / Colour	U/	
8410787020900	08360002	○	6	11,04€
8410787020917	08360014	○	6	14,49€

Mango de 3 funciones - Ahorra agua - Selector antideslizante.
3 functions handshower - Saves water - Antiskid selector ring.

Blister: 112 x 290 x 70 mm



Combi Symbol

Cod. Barras / Bar Code	Ref.	Color / Colour	U/	
8410787021273	09045302	○	4	17,54€
8410787021280	09045314	○	4	22,62€

Mango de 3 funciones - Flexible de plástico de 1,75 m - Soporte Superform - Kit de tacos y tornillos.

3 functions handshower - Plastic shower hose: 1,75 m - Superform handshower support - Kit of screws and plugs.

Blister: 220 x 290 x 70 mm

Masaje / Massage

3 FUNCIONES / 3 FUNCTIONS

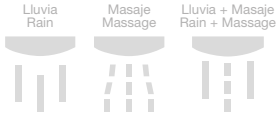

Diámetro
Diameter



Ahorra Agua
Saves Water



Cyclone

Mango de ducha de masaje de 3 funciones. Incorpora un dispositivo limitador de flujo de agua que reduce el consumo aproximadamente en un 50%.

3 functions massage handshower. Includes a water saver device which reduces de water consumption up to approximately 50%.



Cyclone

Cod. Barras / Bar Code	Ref.	Color / Colour	U/
8410787006768	08120002	○	6 10,76€
8410787006782	08120014	○	6 13,84€

Mango de 3 funciones - Ahorra agua.
3 functions handshower - Saves water.

Blister: 112 x 290 x 70 mm



Combi Cyclone

Cod. Barras / Bar Code	Ref.	Color / Colour	U/
8410787006829	09040902	○	4 17,42€
8410787009912	09040914	○	4 19,99€

Mango de 3 funciones - Flexible de plástico de 1,75 m - Soporte Practik - Kit de tacos y tornillos.

3 functions handshower - Plastic shower hose: 1,75 m - Practik handshower support - Kit of screws and plugs.

Blister: 220 x 290 x 70 mm

Masaje / Massage

3 FUNCIONES / 3 FUNCTIONS

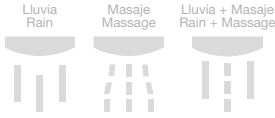

Select

Mango de ducha de masaje de 3 funciones. Incorpora un dispositivo limitador de flujo de agua que reduce el consumo aproximadamente en un 50%.

3 functions massage handshower. Includes a water saver device which reduces de water consumption up to approximately 50%.



Select

Cod. Barras / Bar Code	Ref.	Color / Colour	U/
8410787011830	08220002	○	6 10,04€
8410787011847	08220014	○	6 11,68€

Mango de 3 funciones - Ahorra agua.

3 functions handshower - Saves water.

Blister: 112 x 290 x 70 mm



Combi Select

Cod. Barras / Bar Code	Ref.	Color / Colour	U/
8410787011861	09042202	○	4 15,89€
8410787012677	09042214	○	4 18,76€

Mango de 3 funciones - Flexible de plástico de 1,75 m - Soporte Practik - Kit de tacos y tornillos.

3 functions handshower - Plastic shower hose: 1,75 m - Practik handshower support - Kit of screws and plugs.

Blister: 220 x 290 x 70 mm

Luz led / Led light

1 FUNCIÓN / 1 FUNCTION

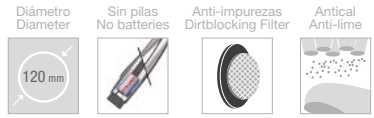
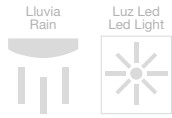

Colors

Mango de ducha con dispositivo de LUZ LED. Función lluvia y membrana anticalcárea. Fabricado en ABS cromado. Incorpora una dinamo que, gracias al movimiento del agua activa 3 diferentes colores que varían en función de la temperatura del agua: Azul: Temperatura inferior a 29°C. Verde: Temperatura entre 30°C y 40°C. Rojo: Temperatura superior a 41°C. Rojo (intermitente): Temperatura superior a 48°C. Área de rociado: Ø 120 mm. Longitud 23 cm. Funciona sin pilas.

Handshower with LED LIGHT system. Rain function with anti-lime membrane. Made in chromed ABS. Includes a dynamo device that, due to the water flow, activates 3 different colours depending on water temperature: Blue: Temperature below 29°C. Green: Temperature between 30°C and 40°C. Red: Temperature over 41°C. Red blinker light: Temperature over 48°C. Spray area: Ø 120 mm. Length 23 cm. No batteries required.



CON INDICADOR LUMINOSO DE TEMPERATURA / WITH TEMPERATURE INDICATOR LIGHT
 DYNAMO: FUNCIONA SIN PILAS / WORKS WITHOUT BATTERIES

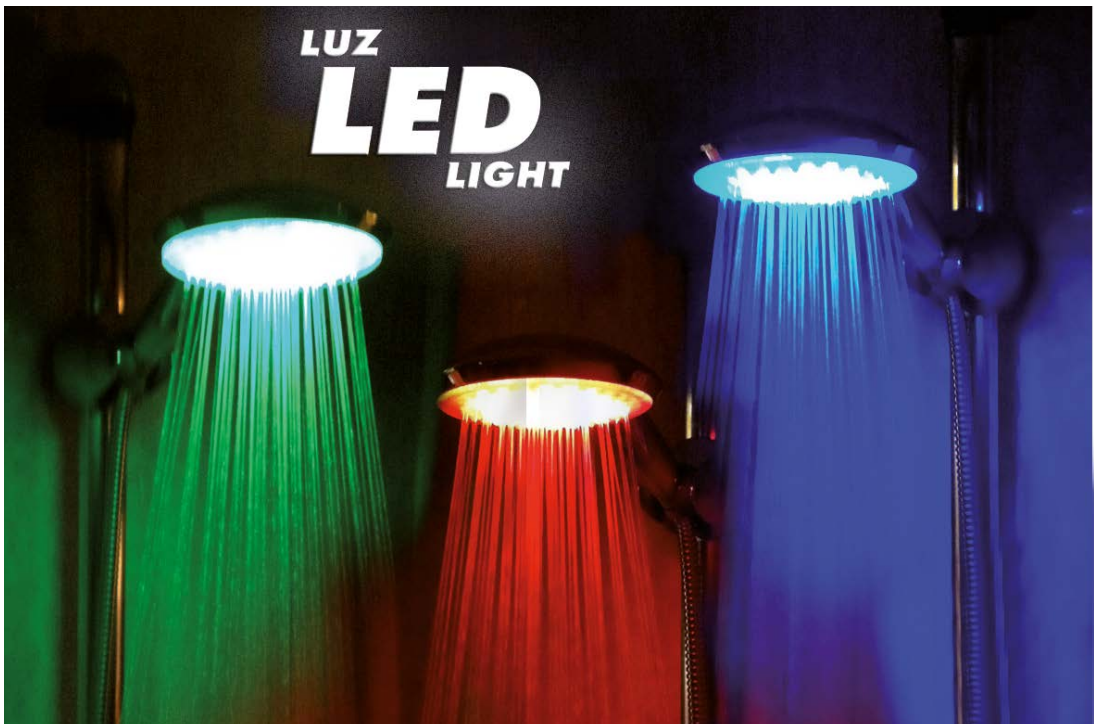

Luz led / Led light



Colors

Cod. Barras / Bar Code	Ref.	Color / Colour	U/ 
8410787027299	08690014		4 34,78€

Mango de 1 función - Anticalcáreo - Ahorra agua - Área de rociado: Ø 120 mm.

1 function handshower - Anti-lime system - Saves water - Rain area: Ø 120 mm.

 Blister: 150 x 290 x 65 mm

* Consultar disponibilidad - Check availability

CONJUNTOS / SHOWER SETS



Combi Colors

Cod. Barras / Bar Code	Ref.	Color / Colour	U/ 
8410787027312	09046914		2 45,94€

Mango de 1 función - Flexible metálico extensible hasta 2 m - Soporte Superform - Kit de tacos y tornillos.

1 function handshower - Metallic shower hose extensible up to 2 m - Superform handshower support.

 Blister: 150 x 320 x 80 mm

* Consultar disponibilidad - Check availability



Variant Colors

Cod. Barras / Bar Code	Ref.	Color / Colour	U/ 
8410787027305	09036914		2 78,54€

Mango de 1 función - Flexible metálico extensible hasta 2 m - Jabonera - Barra Lasser 80 cm - Kit de tacos y tornillos.

1 function handshower - Metallic shower hose extensible up to 2 m - Soap dish - Lasser slide bar: 80 cm - Kit of screws and plugs.

 Blister: 150 X 810 x 100 mm

* Consultar disponibilidad - Check availability



Minimalista / Minimalist

1 FUNCIÓN / 1 FUNCTION

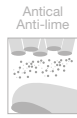

Style

Mango de ducha minimalista tubular. Función lluvia con membrana anticalcárea. Fabricado en ABS. Cromado. Longitud: 22 cm. Disponible sólo en conjunto Combi o Variant.

Tubular minimalist handshower. Rain function with anti-lime membrane. Made in chromed ABS. Length 22 cm. Only available in Combi or Variant shower set.



CONJUNTOS / SHOWER SETS



Combi Style

Cod. Barras / Bar Code	Ref.	Color / Colour	U/
8410787026001	09046014	○	4 24,57€

Mango de 1 función - Anticalcáreo - Soporte Superform - Flexible metálico extensible hasta 2 m - Kit de tacos y tornillos.

1 function handshower - Anti-lime system - Superform handshower support - Metallic shower hose extensible up to 2 m - Kit of screws and plugs.

Blister: 150 x 320 x 50 mm



Variant Style

Cod. Barras / Bar Code	Ref.	Color / Colour	U/
8410787025387	09036014	○	4 39,48€

Mango de 1 función - Flexible metálico extensible hasta 2 m - Barra Practika 75 cm Ø 20 mm - Kit de tacos y tornillos.

1 function handshower - Metallic shower hose extensible up to 2 m - Practika slide bar: 75 cm Ø 20 mm - Kit of screws and plugs.

Blister: 135 x 830 x 70 mm

Gran diámetro / Big diameter

1 FUNCIÓN / 1 FUNCTION



Stone

Mango de ducha de diseño oval. Función lluvia con membrana anticalcárea. Fabricado en ABS cromado. Incorpora un dispositivo limitador del flujo de agua que reduce el consumo aproximadamente un 50%. Área de rociado: 8 x 8 cm. Longitud: 25 cm.

Big diameter oval-shaped handshower. Rain function with anti-lime membrane. Made in chromed ABS. Includes a water saver device which reduces the water consumption up to approximately 50%. Rain area: 8 x 8 cm. Length: 25 cm.



Stone

Cod. Barras / Bar Code	Ref.	Color / Colour	U/	
8410787027459	08620017	○	4	28,70€
8410787026223	08620014	○	4	28,70€

Mango de 1 función - Anticalcáreo - Ahorra agua - Incluye junta filtro anti-impurezas - Área de rociado: 8 x 8 cm.

1 function handshower - Anti-lime system - Saves water - Dirtblocking filter joint included - Rain area: 8 x 8 cm.

Blister: 180 X 320 x 40 mm



CONJUNTOS / SHOWER SETS



Combi Stone

Cod. Barras / Bar Code	Ref.	Color / Colour	U/	
8410787027473	09046217	○	4	34,23€
8410787026247	09046214	○	4	34,23€

Mango de 1 función - Flexible metálico extensible hasta 2 m - Soporte Superform - Kit de tacos y tornillos.

1 function handshower - Metallic shower hose extensible up to 2 m - Superform handshower support.

Blister: 150 x 320 x 50 mm



Variant Stone

Cod. Barras / Bar Code	Ref.	Color / Colour	U/	
8410787027466	09036217	○	2	54,73€
8410787026230	09036214	○	2	54,73€

Mango de 1 función - Flexible metálico extensible hasta 2 m - Barra Practika 75 cm Ø 20 mm - Kit de tacos y tornillos.

1 function handshower - Metallic shower hose extensible up to 2 m - Practika slide bar: 75 cm Ø 20 mm - Kit of screws and plugs.

Blister: 235 x 830 x 70 mm



Happy

Mango de ducha de gran diámetro. Función lluvia con membrana anticalcárea. Fabricado en ABS cromado. Diámetro del difusor: 12 cm. Longitud: 24 cm.

Big diameter handshower. Rain function with anti-lime membrane. Made in chromed ABS. Overhead diameter: 12 cm. Length: 24 cm.



Happy

Cod. Barras / Bar Code	Ref.	Color / Colour	U/
8410787025028	08470014	○	4 17,85€

Mango de 1 función - Anticalcáreo - Incluye junta filtro anti-impurezas - Gran diámetro Ø 12 cm.

1 function handshower - Anti-lime system - Dirtblocking filter joint included - Big diameter Ø 12 cm.

Blister: 150 x 290 x 65 mm



Combi Happy

Cod. Barras / Bar Code	Ref.	Color / Colour	U/ 
8410787025295	09044714		2 26,20€

Mango de 1 función - Flexible metálico extensible hasta 2 m - Soporte Superform - Kit de tacos y tornillos.

1 function handshower - Metallic shower hose extensible up to 2 m - Superform handshower support.

 Blister: 220 x 290 x 80 mm



Variant Happy Suit

Cod. Barras / Bar Code	Ref.	Color / Colour	U/ 
8410787027428	09054814		2 46,15€

Mango de 1 función - Flexible metálico extensible hasta 2 m - Barra Practika 75 cm Ø 20 mm - Kit de tacos y tornillos.

1 function handshower - Metallic shower hose extensible up to 2 m - Practika slide bar: 75 cm Ø 20 mm// Kit of screws and plugs.

 Blister: 235 x 830 x 70 mm



Gran diámetro / Big diameter

1 FUNCIÓN / 1 FUNCTION



Rainbow

Mango de ducha de gran diámetro. Fabricado en ABS. Diámetro del difusor: 12 cm. Longitud: 24,8 cm. Disponible en tres acabados pastel: Gris, verde y naranja. **Bajo consumo de agua: 4,8 lit/min.**

Big diameter handshower. Made in ABS. Overhead diameter: 12 cm. Length: 24,8 cm. Available in tree colors: Grey, green and orange. **Low water consumption: 4.8 lit/min.**



Rainbow

8410787034792	08880002		4	17,80€
8410787034808	08880004		4	17,80€
8410787034815	08880006		4	17,80€

Mango de 1 función - Anticalcáreo - Ahorra agua - Gran diámetro Ø 12 cm

1 function handshower - Anti-lime system - Saves water - Big diameter Ø 12 cm.

Blister: 150 x 290 x 65 mm





Combi Rainbow

8410787034853	09048802		2	30,24€
8410787034860	09048804		2	30,24€
8410787034877	09048806		2	30,24€

Mango de 1 función - Flexible metálico extensible hasta 2 m - Soporte Superform - Kit de tacos y tornillos.

1 function handshower - Metallic shower hose extensible up to 2 m - Superform handshower support.

Blister: 220 x 290 x 80 mm

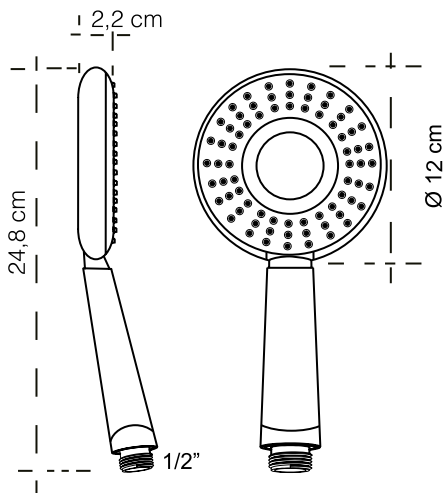

Gran diámetro / Big diameter

3 FUNCIONES / 3 FUNCTIONS

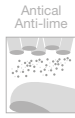

EcoWhite

Mango de ducha función lluvia. Bajo consumo de agua. Fabricado en ABS. El sistema antical permite eliminar fácilmente adherencias calcareas presionando con el dedo sobre la membrana que incorpora el difusor. Area del rociado Ø 100 mm, longitud 24,5 cm.

Rain massage handshower. Saves water. Its anti-lime system offers an easy solution to the limescale problem by simply pressing the fingertip on the membrane of the diffuser. Rain area Ø 100 mm. Length 24,5 cm.

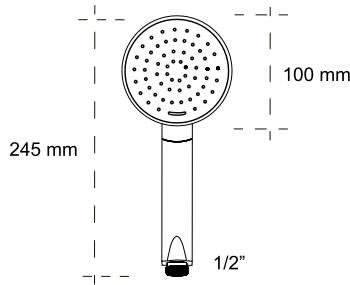

EcoWhite

Cod. Barras / Bar Code	Ref.	Color / Colour	U/
8410787034631	08830017	○	4

16,75€

Mango de 1 función - Anticalcáreo - Gran diámetro Ø 10 cm.
1 function handshower - Anti-lime system - Big diameter Ø 10 cm.

Blister: 150 x 290 x 65 mm



Combi EcoWhite

Cod. Barras / Bar Code	Ref.	Color / Colour	U/ 
8410787034655	09048317	○	2 25,15€

Mango de 1 función - Flexible metálico extensible hasta 2 m - Soporte Superform - Kit de tacos y tornillos.

1 function handshower - Metallic shower hose extensible up to 2 m - Superform handshower support - Kit of screws and plugs.

 Blister: 220 x 290 x 80 mm



Variant EcoWhite

Cod. Barras / Bar Code	Ref.	Color / Colour	U/ 
8410787034679	09058317	○	2 46,15€

Mango de 1 función- Flexible metálico extensible hasta 2 m - Barra Practika 75 cm Ø 20 mm - Kit de tacos y tornillos.

1 function handshower - Metallic shower hose extensible up to 2 m - Practika slide bar: 75 cm Ø 20 mm - Kit of screws and plugs.

 Blister: 235 x 830 x 70 mm

ECO WHITE

DUCHAS QUE LE AYUDAN A AHORRAR AGUA / SHOWER THAT HELPS SAVING WATER

EcoWhite 2F



20

EcoWhite 1F



40

Rociador/Overhead



65



Diámetro
Diameter



Antical
Anti-lime



Fox

Mango de ducha de gran diámetro. Función lluvia con membrana anticalcárea. Fabricado en ABS cromado. Diámetro del difusor: 10 cm. Longitud: 23,5 cm.

Big diameter handshower. Rain function with anti-lime membrane. Made in chromed ABS. Overhead diameter: 10 cm. Length: 23,5 cm.



Fox

Cod. Barras / Bar Code	Ref.	Color / Colour	U/	
8410787033894	08780014	○	4	14,91€

Mango de 1 función - Anticalcáreo - Gran diámetro Ø 10 cm.

1 function handshower - Anti-lime system - Big diameter Ø 10 cm.

Blister: 150 x 290 x 65 mm



Combi Fox

Cod. Barras / Bar Code	Ref.	Color / Colour	U/ 	
8410787033900	09047814	○	2	23,00€

Mango de 1 función - Flexible metálico extensible hasta 2 m -
Soporte Superform - Kit de tacos y tornillos.

1 function handshower - Metallic shower hose extensible up to
2 m - Superform handshower support.

 Blister: 220 x 290 x 80 mm

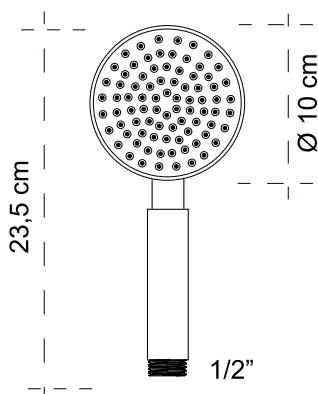

Gran diámetro / Big diameter

1 FUNCIÓN / 1 FUNCTION



Forum

Mango de ducha de gran diámetro. Función lluvia con membrana anticalcárea. Fabricado en ABS cromado. Diámetro del difusor: 15 cm. Longitud: 29 cm.

Big diameter handshower. Rain function with anti-lime membrane. Made in chromed ABS. Overhead diameter: 15 cm. Length: 29 cm.



Forum

Cod. Barras / Bar Code	Ref.	Color / Colour	U/
8410787025011	08460014	○	4 20,75€

Mango de 1 función - Anticalcáreo - Incluye junta filtro anti-impurezas - Gran diámetro Ø 15 cm.

1 function handshower - Anti-lime system - Dirtblocking filter joint included - Big diameter Ø 15 cm.

Blister: 175 x 350 x 60 mm



Combi Forum

Cod. Barras / Bar Code	Ref.	Color / Colour	U/
8410787026032	09044614	○	4 31,65€

Mango de 1 función - Flexible metálico extensible hasta 2 m - Soporte Superform - Kit de tacos y tornillos.

1 function handshower - Metallic shower hose extensible up to 2 m - Superform handshower support - Kit of screws and plugs.

Blister: 340 X 250 X 80 mm

Antical / Anti-lime

1 FUNCIÓN / 1 FUNCTION

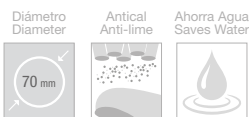

Eclipse

Mango de ducha anticalcáreo de 1 función. El sistema antical permite eliminar fácilmente las adherencias calcáreas presionando con el dedo sobre la membrana del difusor. Incorpora un dispositivo limitador de flujo de agua que reduce el consumo aproximadamente un 50%.

1 function anti-lime handshower. Its anti-lime system offer an easy solution to the limescale problem by simply pressing the fingertip on the membrane of the diffuser. Includes a water saver device which reduces the water consumption up to approximately 50%.



Eclipse

Cod. Barras / Bar Code	Ref.	Color / Colour	U/
8410787010291	08180014	○	2 20,50€

Mango de 1 función - Anticalcáreo - Ahorra agua.

1 jet handshower - Anti-lime system - Saves water.

Blister: 220 x 290 x 80 mm



CONJUNTOS / SHOWER SETS



Combi Eclipse

Cod. Barras / Bar Code	Ref.	Color / Colour	U/
8410787028609	09041814	○	2 27,83€

Mango de 1 función - Flexible metálico extensible hasta 2 m - Soporte Superform - Kit de tacos y tornillos.

1 function handshower - Metallic shower hose extensible up to 2 m - Superform handshower support - Kit of screws and plugs.

Blister: 220 x 290 x 80 mm



Variant Eclipse Suit

Cod. Barras / Bar Code	Ref.	Color / Colour	U/
8410787028678	09051814	○	2 48,99€

Mango de 1 función - Flexible metálico extensible hasta 2 m - Barra Practika 75 cm Ø 20 mm - Kit de tacos y tornillos.

1 function handshower - Metallic shower hose extensible up to 2 m - Practika slide bar: 75 cm Ø 20 mm - Kit of screws and plugs.

Blister: 235 x 830 x 70 mm

Antical / Anti-lime

1 FUNCIÓN / 1 FUNCTION

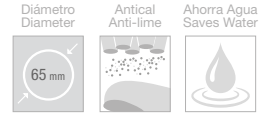

Navy

Mango de ducha anticalcáreo de 1 función. El sistema antical permite eliminar fácilmente las adherencias calcáreas presionando con el dedo sobre la membrana del difusor. Incorpora un dispositivo limitador de flujo de agua que reduce el consumo aproximadamente un 50%.

1 function anti-lime handshower. Its anti-lime system offer an easy solution to the limescale problem by simply pressing the fingertip on the membrane of the diffuser. Includes a water saver device which reduces the water consumption up to approximately 50%.



Navy

Cod. Barras / Bar Code	Ref.	Color / Colour	U/
8410787020931	08370002	○	6 9,63€
8410787020948	08370014	○	6 12,40€

Mango de 1 función - Anticalcáreo - Ahorra agua.
1 function handshower - Anti-lime system - Saves water.

Blister: 112 x 290 x 70 mm



Combi Navy

Cod. Barras / Bar Code	Ref.	Color / Colour	U/
8410787021303	09045402	○	4 16,19€
8410787021310	09045414	○	4 18,96€

Mango de 1 función - Cromado: Flexible metálico extensible hasta 2 m - Blanco: Flexible de plástico de 1,75 m - Soporte Superform - Kit de tacos y tornillos.

1 function handshower - Chrome: Metallic shower hose extensible up to 2 m - White: plastic shower hose: 1,75 m - Superform handshower support - Kit of screws and plugs.

Blister: 220 x 290 x 70 mm

Antical / Anti-lime

1 FUNCIÓN / 1 FUNCTION

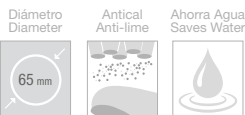

Swing

Mango de ducha anticalcáreo de 1 función. El sistema antical permite eliminar fácilmente las adherencias calcáreas presionando con el dedo sobre la membrana del difusor. Incorpora un dispositivo limitador de flujo de agua que reduce el consumo aproximadamente un 50%.

1 function anti-lime handshower. Its anti-lime system offer an easy solution to the limescale problem by simply pressing the fingertip on the membrane of the diffuser. Includes a water saver device which reduces the water consumption up to approximately 50%.



Swing

Cod. Barras / Bar Code	Ref.	Color / Colour	U/
8410787020962	08380002	○	6 9,63€
8410787020979	08380014	○	6 12,40€

Mango de 1 función - Anticalcáreo - Ahorra agua.

1 function handshower - Anti-lime system - Saves water.

Blister: 112 x 290 x 70 mm

CONJUNTOS / SHOWER SETS



Combi Swing

Cod. Barras / Bar Code	Ref.	Color / Colour	U/
8410787021334	09045502	○	4 16,19€
8410787021341	09045514	○	4 18,96€

Mango de 1 función - Cromado: Flexible metálico extensible hasta 2 m - Blanco: Flexible de plástico de 1,75 m - Soporte Superform - Kit de tacos y tornillos.

1 function handshower - Chrome: Metallic shower hose extensible up to 2 m - White: plastic shower hose: 1,75 m - Superform handshower support - Kit of screws and plugs.

Blister: 220 x 290 x 70 mm



Variant Swing

Cod. Barras / Bar Code	Ref.	Color / Colour	U/
8410787021167	09035502	○	2 24,60€
8410787021174	09035514	○	2 27,16€

Mango de 1 función - Flexible de plástico de 1,75 m - Barra Excalibur 60 cm Ø 20 mm - Kit de tacos y tornillos.

1 function handshower - Plastic shower hose: 1,75 m - Excalibur slide bar: 60 cm Ø 20 mm - Kit of screws and plugs.

Blister: 193 x 705 x 70 mm

Antical / Anti-lime

1 FUNCIÓN / 1 FUNCTION

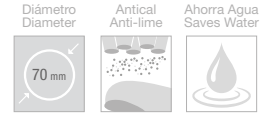

Optima

Mango de ducha anticalcáreo de 1 función. El sistema antical permite eliminar fácilmente las adherencias calcáreas presionando con el dedo sobre la membrana del difusor. Incorpora un dispositivo limitador de flujo de agua que reduce el consumo aproximadamente un 50%.

1 function anti-lime handshower. Its anti-lime system offer an easy solution to the limescale problem by simply pressing the fingertip on the membrane of the diffuser. Includes a water saver device which reduces the water consumption up to approximately 50%.



Optima

Cod. Barras / Bar Code	Ref.	Color / Colour	U/
8410787005518	08060202	○	6 8,20€
8410787005525	08060214	○	6 11,27€

Mango de 1 función - Anticalcáreo - Ahorra agua.
1 function handshower - Anti-lime system - Saves water.

Blister: 112 x 290 x 80 mm



Combi Optima

Cod. Barras / Bar Code	Ref.	Color / Colour	U/
8410787005549	09040602	○	4 13,73€
8410787008045	09040614	○	4 17,63€

Mango de 1 función - Flexible de plástico de 1,75 m - Soporte Practik - Kit de tacos y tornillos.

1 function handshower - Plastic shower hose: 1,75 m - Practik handshower support - Kit of screws and plugs.

Blister: 220 x 290 x 70 mm

Antical / Anti-lime

1 FUNCIÓN / 1 FUNCTION

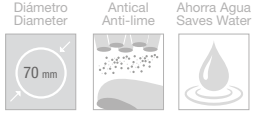

Climax

Mango de ducha anticalcáreo de 1 función. El sistema antical permite eliminar fácilmente las adherencias calcáreas presionando con el dedo sobre la membrana del difusor. Incorpora un dispositivo limitador de flujo de agua que reduce el consumo aproximadamente un 50%.

1 function anti-lime handshower. Its anti-lime system offer an easy solution to the limescale problem by simply pressing the fingertip on the membrane of the diffuser. Includes a water saver device which reduces the water consumption up to approximately 50%.



Climax

Cod. Barras / Bar Code	Ref.	Color / Colour	U/	
8410787013391	08260002J	○	6	7,99€
8410787013407	082600014	○	6	11,07€

Mango de 1 función - Anticalcáreo - Ahorra agua.
1 function handshower - Anti-lime system - Saves water.

Blister: 112 x 290 x 80 mm

CONJUNTOS / SHOWER SETS



Combi Climax

Cod. Barras / Bar Code	Ref.	Color / Colour	U/	
8410787012950	09042602	○	4	13,43€
8410787012967	09042614	○	4	17,22€

Mango de 1 función - Cromado: Flexible metálico extensible hasta 2 m - Blanco: Flexible de plástico de 1,75 m - Soporte Practik - Kit de tacos y tornillos.

1 function handshower - Chrome: Metallic shower hose extensible up to 2 m - White: Plastic shower hose: 1,75 m - Practik handshower support - Kit of screws and plugs.

Blister: 220 x 290 x 70 mm



Variant Climax

Cod. Barras / Bar Code	Ref.	Color / Colour	U/	
8410787012912	09032602	○	2	21,22€
8410787012929	09032614	○	2	25,08€

Mango de 1 función - Flexible de plástico de 1,75 m - Barra Excalibur 60 cm Ø 20 mm - Kit de tacos y tornillos.

1 function handshower - Plastic shower hose: 1,75 m - Excalibur slide bar: 60 cm Ø 20 mm - Kit of screws and plugs.

Blister: 193 x 705 x 70 mm

Antical / Anti-lime

1 FUNCIÓN / 1 FUNCTION

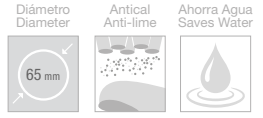

Juliet

Mango de ducha anticalcáreo de 1 función. El sistema antical permite eliminar fácilmente las adherencias calcáreas presionando con el dedo sobre la membrana del difusor. Incorpora un dispositivo limitador de flujo de agua que reduce el consumo aproximadamente un 50%.

1 function anti-lime handshower. Its anti-lime system offer an easy solution to the limescale problem by simply pressing the fingertip on the membrane of the diffuser. Includes a water saver device which reduces the water consumption up to approximately 50%.



Juliet

Cod. Barras / Bar Code	Ref.	Color / Colour	U/
8410787011908	08230002	○	6 7,74€
8410787011915	08230014	○	6 10,71€

Mango de 1 función - Anticalcáreo - Ahorra agua.
1 function handshower - Anti-lime system - Saves water.

Blister: 112 x 290 x 70 mm



CONJUNTOS / SHOWER SETS



Combi Juliet

Cod. Barras / Bar Code	Ref.	Color / Colour	U/
8410787011960	09042302	○	4 13,02€
8410787012691	09042314	○	4 16,55€

Mango de 1 función - Cromado: Flexible metálico extensible hasta 2 m - Blanco: Flexible de plástico de 1,75 m - Soporte Practik - Kit de tacos y tornillos.

1 function handshower - Chrome: Metallic shower hose extensible up to 2 m - White: Plastic shower hose: 1,75 m - Practik handshower support - Kit of screws and plugs.

Blister: 220 x 290 x 70 mm



Variant Juliet

Cod. Barras / Bar Code	Ref.	Color / Colour	U/
8410787011939	09032302	○	2 20,35€
8410787011946	09032314	○	2 25,01€

Mango de 1 función - Flexible de Plástico de 1,75 m - Barra Excalibur 60 cm Ø 20 mm - Kit de tacos y tornillos.

1 function handshower - Plastic shower hose: 1,75 m - Excalibur slide bar: 60 cm Ø 20 mm - Kit of screws and plugs.

Blister: 193 x 705 x 70 mm

Lluvia / Rain

1 FUNCIÓN / 1 FUNCTION

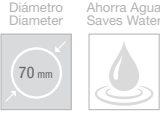

Nobel

Mango de ducha universal de 1 función. Incorpora un dispositivo limitador de flujo de agua que reduce el consumo aproximadamente un 50%. Disponible sólo en conjunto Combi o Variant.

1 function universal handshower. Includes a water saver device which reduces the water consumption up to approximately 50%. Only available in Combi or Variant shower set.

CONJUNTOS / SHOWER SETS



Combi Nobel

Cod. Barras / Bar Code	Ref.	Color / Colour	U/
8410787019164	09043714	○	4 16,83€

Mango de 1 función - Flexible metálico extensible hasta 2 m - Soporte Superform - Kit de tacos y tornillos.

1 function handshower - Metallic shower hose extensible up to 2 m - Superform handshower support - Kit of screws and plugs.

Blister: 220 x 290 x 70 mm



Variant Nobel

Cod. Barras / Bar Code	Ref.	Color / Colour	U/
8410787019171	09033714	○	2 26,39€

Mango de 1 función - Flexible metálico extensible hasta 2 m - Barra Excalibur 60 cm Ø 20 mm - Kit de tacos y tornillos.

1 function handshower - Metallic shower hose extensible up to 2 m - Excalibur slide bar: 60 cm Ø 20 mm - Kit of screws and plugs.

Blister: 193 x 705 x 70 mm

Lluvia / Rain

1 FUNCIÓN / 1 FUNCTION



Neo

Mango de ducha universal de 1 función. Incorpora un dispositivo limitador de flujo de agua que reduce el consumo aproximadamente un 50%.

1 function universal handshower. Includes a water saver device which reduces the water consumption up to approximately 50%.



Neo

Cod. Barras / Bar Code	Ref.	Color / Colour	U/
8410787020993	08390002	○	6 7,17€
8410787021006	08390014	○	6 9,84€

Mango de 1 función - Ahorra agua.
1 function handshower - Saves water.

Blister: 112 x 290 x 70 mm

CONJUNTOS / SHOWER SETS



Combi Neo

Cod. Barras / Bar Code	Ref.	Color / Colour	U/
8410787021365	09045602	○	4 14,04€
8410787021372	09045614	○	4 17,31€

Mango de 1 función - Cromado: Flexible metálico extensible hasta 2 m - Blanco: Flexible de plástico de 1,75 m - Soporte Superform - Kit de tacos y tornillos.

1 function handshower - Chrome: Metallic shower hose extensible up to 2 m - White: Plastic shower hose: 1,75 m - Superform handshower support - Kit of screws and plugs.

Blister: 220 x 290 x 70 mm



Variant Neo

Cod. Barras / Bar Code	Ref.	Color / Colour	U/
8410787021181	09035602	○	2 22,19€
8410787021198	09035614	○	2 27,01€

Mango de 1 función - Flexible de plástico de 1,75 m - Barra Excalibur 60 cm Ø 20 mm - Kit de tacos y tornillos.

1 function handshower - Plastic shower hose: 1,75 m - Excalibur slide bar: 60 cm Ø 20 mm - Kit of screws and plugs.

Blister: 193 x 705 x 70 mm



Soul

Mango de ducha universal de 1 función. Incorpora un dispositivo limitador de flujo de agua que reduce el consumo aproximadamente un 50%.

1 function universal handshower. Includes a water saver device which reduces the water consumption up to approximately 50%.



Soul

Cod. Barras / Bar Code	Ref.	Color / Colour	U/
8410787021020	08400002	○	6 7,17€
8410787021037	08400014	○	6 9,84€

Mango de 1 función - Ahorra agua.
1 function handshower - Saves water.

Blister: 112 x 290 x 70 mm



Combi Soul

Cod. Barras / Bar Code	Ref.	Color / Colour	U/
8410787021396	09045702	○	4 14,04€
8410787021402	09045714	○	4 17,31€

Mango de 1 función - Cromado: Flexible metálico extensible hasta 2 m - Blanco: Flexible de plástico de 1,75 m - Soporte Superform - Kit de tacos y tornillos.

1 function handshower - Chrome: Metallic shower hose extensible up to 2 m - White: Plastic shower hose: 1,75 m - Superform handshower support - Kit of screws and plugs.

Blister: 220 x 290 x 70 mm

Lluvia / Rain

1 FUNCIÓN / 1 FUNCTION



Princess

Mango de ducha universal de 1 función. Incorpora un dispositivo limitador de flujo de agua que reduce el consumo aproximadamente un 50%.

1 function universal handshower. Included a water saver device which reduces the water consumption up to approximately 50%



Princess

Cod. Barras / Bar Code	Ref.	Color / Colour	U/	
8410787011984	08240002	○	6	4,82€
8410787011977	08240001J	●	6	4,82€
8410787011991	08240014	○	6	6,76€

Mango de 1 función - Ahorra agua.
1 function handshower - Saves water.

Blister: 112 x 290 x 70 mm



Combi Princess

Cod. Barras / Bar Code	Ref.	Color / Colour	U/	
8410787012035	09042402	○	4	11,43€
8410787012028	09042401	●	4	11,43€
8410787012714	09042414	○	4	13,46€

Mango de 1 función - Cromado: Flexible metálico extensible hasta 2 m - Blanco: Flexible de plástico de 1,75 m - Soporte Practik - Kit de tacos y tornillos.

1 function handshower - Chrome: Metallic shower hose extensible up to 2 m - White: Plastic shower hose: 1,75 m - Practik handshower support - Kit of screws and plugs.

Blister: 220 x 290 x 70 mm

Lluvia / Rain

1 FUNCIÓN / 1 FUNCTION



Polo

Mango de ducha universal de 1 función. Incorpora un dispositivo limitador de flujo de agua que reduce el consumo aproximadamente un 50%.

1 function universal handshower. Includes a water saver device which reduces the water consumption up to approximately 50%.



Polo

Cod. Barras / Bar Code	Ref.	Color / Colour	U/
8410787021051	08410002	○	6 3,50€
8410787021075	08410031	●	6 3,60€
8410787021068	08410014	○	6 5,81€

Mango de 1 función - Ahorra agua.
1 function handshower - Saves water.

Blister: 112 x 290 x 40 mm

CONJUNTOS / SHOWER SETS



Combi Polo

Cod. Barras / Bar Code	Ref.	Color / Colour	U/
8410787021426	09045802	○	4 11,13€
8410787021440	09045831	●	4 11,13€
8410787021433	09045814	○	4 12,58€

Mango de 1 función - Flexible de plástico de 1,75 m - Soporte Praktik - Kit de tacos y tornillos.

1 function handshower - Plastic shower hose: 1,75 m - Praktik handshower support - Kit of screws and plugs.

Blister: 220 x 290 x 40 mm



Variant Polo

Cod. Barras / Bar Code	Ref.	Color / Colour	U/
8410787021228	09035802	○	2 17,96€
8410787021235	09035814	○	2 24,61€

Mango de 1 función - Flexible de plástico de 1,75 m - Barra Excalibur 60 cm Ø 20 mm - Kit de tacos y tornillos.

1 function handshower - Plastic shower hose: 1,75 m - Excalibur slide bar: 60 cm Ø 20 mm. - Kit of screws and plugs.

Blister: 193 x 705 x 50 mm

Lluvia / Rain

1 FUNCIÓN / 1 FUNCTION



Golf

Mango de ducha universal de 1 función. Incorpora un dispositivo limitador de flujo de agua que reduce el consumo aproximadamente un 50%.

1 function universal handshower. Includes a water saver device which reduces the water consumption up to approximately 50%.



Golf

Cod. Barras / Bar Code	Ref.	Color / Colour	U/
8410787001527	08010102	○	6 2,47€
8410787001510	08010101	●	6 2,47€
8410787027619	08010104	●	6 2,77€
8410787027626	08010105	●	6 2,77€
8410787027633	08010106	●	6 2,77€
8410787027640	08010107	●	6 2,77€
8410787007048	08010114	○	6 4,84€

Mango de 1 función - Ahorra agua.
1 function handshower - Saves water.

Blister: 112 x 290 x 40 mm



Combi Golf

Cod. Barras / Bar Code	Ref.	Color / Colour	U/
8410787002111	09040102	○	4 9,58€
8410787002104	09040101	●	4 9,58€
8410787009080	09040114	○	4 13,07€

Mango de 1 función - Flexible de plástico de 1,75 m - Soporte Praktik - Kit de tacos y tornillos.

1 function handshower - Plastic shower hose: 1,75 m - Praktik handshower support - Kit of screws and plugs.

Blister: 220 x 290 x 40 mm

Lluvia / Rain

1 FUNCIÓN / 1 FUNCTION

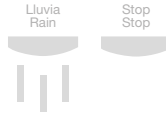

Cartoon



Guay y Junior

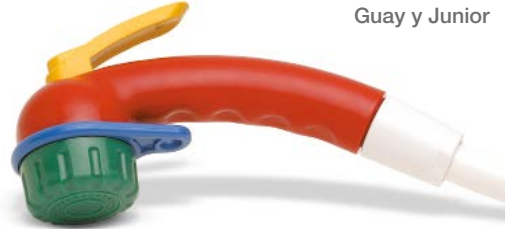

CONJUNTOS / SHOWER SETS



Cartoon

Cod. Barras / Bar Code	Ref.	Color / Colour	U/	
8410787021082	08420029		6	13,22€
8410787021099	08420030		6	13,22€

Mango de 1 función - Función stop - Ahorra agua.
1 function handshower - Stop function - Saves water.

Blister: 112 x 290 x 40 mm



Junior

Cod. Barras / Bar Code	Ref.	Color / Colour	U/	
8410787017672	08020002		8	6,99€
8410787017665	08020014		8	7,74€

Mango de 1 función - Función stop - Ahorra agua.
1 function handshower - Stop function - Saves water.

Blister: 150 X 150 x 30 mm



Combi Cartoon

Cod. Barras / Bar Code	Ref.	Color / Colour	U/	
8410787021457	09045929		4	19,80€
8410787021464	09045930		4	19,80€

Mango de 1 función - Flexible de plástico de 1,75 m - Soporte Superform - Kit de tacos y tornillos.
1 function handshower - Plastic shower hose: 1,75 m - Superform handshower support - Kit of screws and plugs.

Blister: 220 x 290 x 40 mm



Combi Guay

Cod. Barras / Bar Code	Ref.	Color / Colour	U/	
8410787017726	09040299		4	14,76€

Mango de 1 función - Función stop - Flexible de plástico de 1,75 m - Soporte Max - Kit de tacos y tornillos.
1 function handshower - Stop function - Plastic shower hose: 1,75 m - Max handshower support - Kit of screws and plugs.

Blister: 150 x 320 x 30 mm

Chess

Columna con grifería monomando de latón con cartucho interior de discos cerámicos y tubo de acero inoxidable. Incluye un rociador de gran diámetro, un mango de ducha Party de masaje de 4 funciones y un soporte para mango, ambos fabricados en ABS cromado. La selección entre el rociador y la ducha se realiza mediante una válvula de tres vías de latón que cambia la dirección simplemente con accionar un botón. Incluye además un flexible metálico de 1,5m. Incluye todas las piezas necesarias para su instalación.

Column with brass mixer tap with ceramic discs cartridge inside and a stainless steel tube. Includes a big diameter anti-lime overhead, Party 4 jets massage handshower and one handshower support, both made of ABS. The choice between them is made by a brass threeway valve that change the direction easily by triggering a button. Also includes one metallic 1,5m shower hose. Includes all the needed pieces for the installation are included in the set.

All the needed pieces for the installation are included in the set.

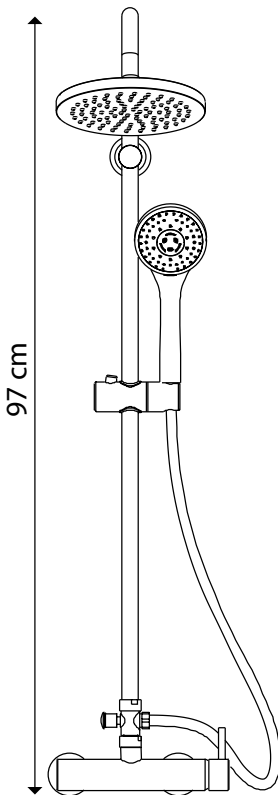

COMPONENTES / COMPONENTS

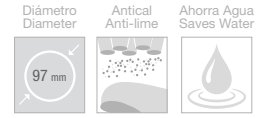
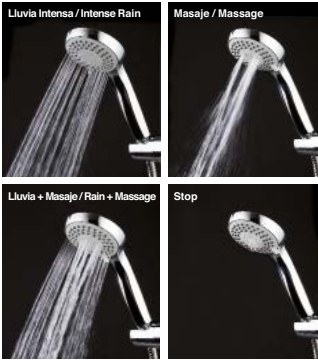

4 FUNCIONES / 4 FUNCTIONS

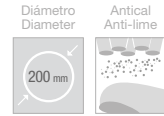
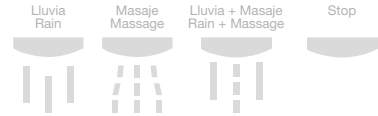



1 FUNCIÓN / 1 FUNCTION

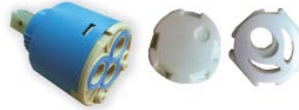

Grifería de Latón con cartucho interior de discos cerámicos.
Brass fittings with inner cartridge with ceramic discs.



Chess

Cod. Barras / Bar Code	Ref.	Color / Colour	U/ 
8410787030404	22983514		1 228.90€

Mango 4 funciones antical Ø 9,7 cm - Rociador 1 función antical
- Medidas flexible metálico: Conexión a mango 1,5m - Medida columna 97 cm x 50 cm - Tubo 20 mm.

4 functions Ø 9,7 cm handshower - 1 function antilime overhead -
Metallic shower hose sizes: 1,5 m - Column size: 97 cm x 30,4 cm -
Tube: 20 mm.

 Caja - Box: 1050 x 360 x 80 mm

Columnas / Columns

1 FUNCIÓN / 1 FUNCTION

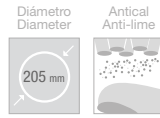
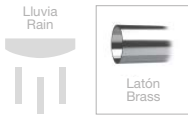

Tower

Tower permite disfrutar de modernos rociadores de gran tamaño sin renunciar al mango tradicional. La selección de una u otra opción se produce mediante la válvula de tres vías que cambia la dirección del flujo del agua simplemente con accionar un botón. **Columna y válvula fabricada en latón.** Rociador, mango de ducha y cursor fabricados en ABS. Incluye todas las piezas necesarias para su instalación. No incluye grifería.

The shower column Tower enhance the different ways of using the water in every bathroom. The choice between them is made by a three-way valve that changes the flow direction easily by triggering a button. **Column and valve made of brass.** Overhead, handshower and showerhead made of ABS. All the needed pieces for their installation are included in the set. Faucet not included.

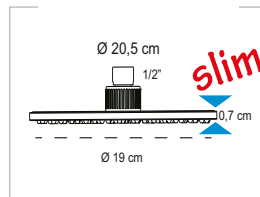
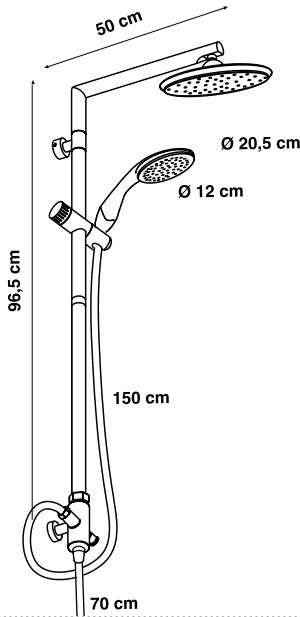

LATÓN BRASS



Tower

Cod. Barras / Bar Code	Ref.	Color / Colour	U/
8410787025103	22100214	○	2 222,77€

Mango 1 función antica Ø 12 cm - Rociador 1 función antica Ø 20,5 cm - Medidas flexibles metálicos: Conexión a mango 1,5 m - conexión a grifería 70 cm - Medidas columna: 96.5 cm x 35.5 cm - Tubo: Ø 25 mm.

1 function anti-lime handshower Ø 12 cm // 1 function anti-lime overhead Ø 20 cm - Metallic shower hoses sizes: Connected to the handshower: 1,5 m. Connected to the tap: 70 cm - Column sizes: 96.5 cm x 35.5 cm - Tube: Ø 25 mm.

Caja - Box: 520 cm x 375cm x 95 mm

Lluvia
Rain

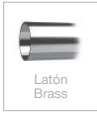

Antical
Anti-lime



Future

Future permite disfrutar de modernos rociadores de gran tamaño sin renunciar al mango tradicional. La selección de una u otra opción se produce mediante la válvula de tres vías que cambia la dirección del flujo del agua simplemente con accionar un botón. **Columna y válvula fabricada en latón.** Rociador, mango de ducha y cursor fabricados en ABS. Incluye todas las piezas necesarias para su instalación. No incluye grifería.

The shower column Future enhance the different ways of using the water in every bathroom. The choice between them is made by a threeway valve that changes the flow direction easily by triggering a button. **Column and valve made of brass.** Overhead, handshower and shower support made of ABS. All the needed pieces for their installation are included in the set. Faucet not included.

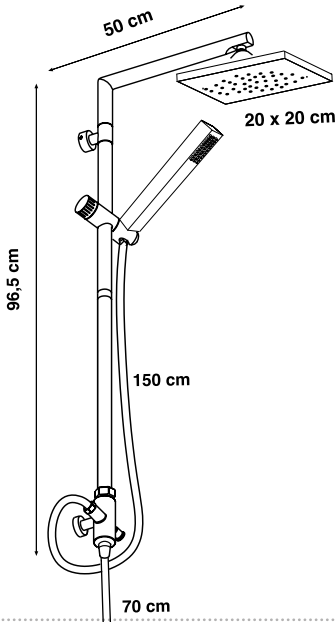

**LATÓN
BRASS**



Future

Cod. Barras / Bar Code	Ref.	Color / Colour	U/
8410787025097	22100114	○	2 222,77€

Mango 1 función antical - Rociador cuadrado de 1 función antical 20 cm x 20 cm. - Medidas flexibles metálicos: Conexión a mango 1,5 m - conexión a grifería 70 cm - Medidas columna: 96,5 cm x 35,5 cm - Tubo: Ø 25 mm.

1 function anti-lime handshower - 1 function anti-lime square overhead 20 cm x 20 cm. Ø 20 cm - Metallic shower hoses sizes: Connected to the handshower: 1,5 m. Connected to the tap: 70 cm - Column sizes: 96,5 cm x 35,5 cm - Tube: Ø 25 mm.

Caja - Box: 520 cm x 375cm x 95 mm

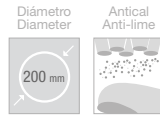
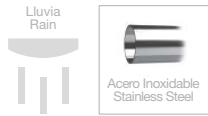

Tango

Compuesta por tubo de acero inoxidable, rociador circular de gran área de rociado y un mango de ducha anticalcáreo de Ø10 cm. La selección de una opción u otra se realiza mediante la válvula intercambiadora que incorpora el set.

Shower column that consists of an stainless steel tube, a round shaped rain overhead and Ø10 cm anti-lime handshower. The change of the two functions is made with a three-way valve which is included in the set.

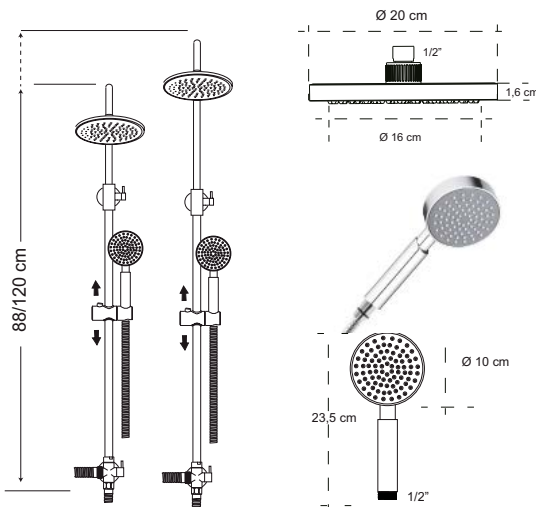

Tango

Cod. Barras / Bar Code	Ref.	Color / Colour	U/
8410787027121	22981114	○	2 185,81€

Rociador: Lluvia antical. - Mango: Lluvia antical. - Columna: Acero inoxidable - Válvula: Latón. - Rociador, mango ducha y cursor: A.B.S. cromado - Flexibles: Acero inoxidable - Longitud total: Extensible de 88 a 120 cm. - Ancho aproximado: 50 cm.

Overhead: Anti-lime rain. - Handshower: Anti-lime rain - Column: Stainless Steel - Valve: Brass. - Overhead, Handshower & shower support: A.B.S. - Shower hoses: Stainless Steel - Total length: Extensible from 88 a 120 cm. - Width approximated: 50 cm.

Caja - Box: 1050 x 360 x 80 mm

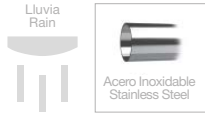

Folk

Compuesta por tubo de acero inoxidable, rociador cuadrado de gran área de rociado y un mango de ducha anticalcáreo de 8 x 8 cm. La selección de una opción u otra se realiza mediante la válvula intercambiadora que incorpora el set.

Shower column that consists of an stainless steel tube, a square shaped rain overhead and square anti-lime handshower. The change of the two functions is made with a three-way valve which is included in the set.

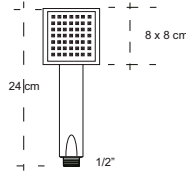
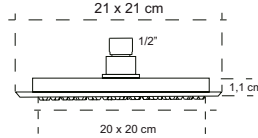
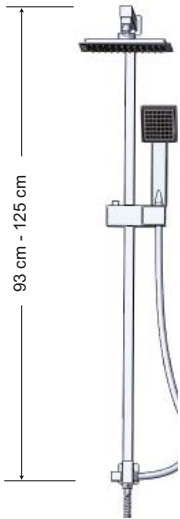

Folk

Cod. Barras / Bar Code	Ref.	Color / Colour	U/
8410787027114	22981014	○	2 185,81€

Rociador: Lluvia antical. - Mango: Lluvia antical. - Columna: Acero inoxidable - Válvula: Latón. - Rociador, mango ducha y cursor: A.B.S. - Flexibles: Acero inoxidable - Longitud total: Extensible de 93 cm a 125 cm - Ancho aproximado: 52 cm.

Overhead: Anti-lime rain. - Handshower: Anti-lime rain - Column: Stainless Steel - Valve: Brass. - Overhead, Handshower & shower support: A.B.S. - Shower hoses: Stainless Steel - Total length: Extensible from 93 to 125 cm - Width approximated: 52 cm..

Caja - Box: 1050 x 360 x 85 mm



Rociadores / Rain overheads

1 FUNCIÓN / 1 FUNCTION

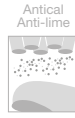

Tonic

Rociador de líneas cuadradas fabricado en ABS cromado. Con enlace de rótula orientable de 1/2". Medidas exterior 21 cm x 21 cm. Gran área de rociado de 20 x 20 cm. Salidas de agua con membrana anticalcárea.

Square rain overhead shower made in chrome ABS. 1/2" swivel connection. External sizes: 21 cm x 21 cm. Big area of shower: 20 x 20 cm. Water way out with anti-lime membrane.



Tonic

Cod. Barras / Bar Code	Ref.	Color / Colour	U/
8410787025066	22090114	○	2 47,72€

Blister: 265 x 310 x 90 mm

1 FUNCIÓN / 1 FUNCTION

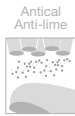

Smart

Rociador circular de líneas planas fabricado en ABS. Enlace de rótula orientable de 1/2". Rociador de gran diámetro Ø 20 cm. Función lluvia con membrana anticalcárea.

Round shape rain overhead shower made in ABS. 1/2" swivel connection. Big area of shower: Ø 20 cm. Rain function with anti-lime membrane.



Smart

Cod. Barras / Bar Code	Ref.	Color / Colour	U/
8410787025073	22090214	○	2 43,00€

Blister: 265 x 310 x 90 mm

Rociadores / Rain overheads

1 FUNCIÓN / 1 FUNCTION

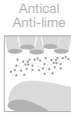
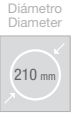

EcoWhite

Rociador circular de líneas planas fabricado en ABS. Enlace de rótula orientable de 1/2". Rociador de gran diámetro Ø 21 cm. Función lluvia con membrana anticalcárea.

Round shape rain overhead shower made in ABS. 1/2" swivel connection. Big area of shower: Ø 21 cm. Rain function with anti-lime membrane.



EcoWhite

Cod. Barras / Bar Code	Ref.	Color / Colour	U/
8410787034693	22090417	○	2 41,95€

Caja - Box: 215cm x 215cm x 60cm

ECO WHITE

DUCHAS QUE LE AYUDAN A AHORRAR AGUA / SHOWER THAT HELPS SAVING WATER

EcoWhite 2F



20

EcoWhite 1F



40

Rociador/Overhead



65

Brazos de ducha / Shower arms

BRAZO DUCHA A PARED / WALL SHOWER ARM



Diámetro
Diameter



LATÓN
BRASS



Corner

Cod. Barras / Bar Code	Ref.	Color / Colour	U/
8410787025035	22080314		4 37,21€

Brazo de ducha a pared - Longitud: 38 cm - Ø 30 mm - Enlace a pared de 1/2" - Enlace a rociador de 1/2" - Nuevo diseño.

Straight shower arm - Length: 38 cm - Ø 30 mm - 1/2" connection to the wall - 1/2" connection to the overhead shower - New design.

Caja - Box: 400 x 55 x 55 mm



Diámetro
Diameter



Arco

Cod. Barras / Bar Code	Ref.	Color / Colour	U/
8410787025059	22080514		4 26,01€

Brazo de ducha a pared - Longitud: 38 cm - Ø 20 mm - Enlace a pared de 1/2" - Enlace a rociador de 1/2".

Straight shower arm - Length: 38 cm - Ø 20 mm - 1/2" connection to the wall - 1/2" connection to the overhead shower

Caja - Box: 400 x 100 x 25 mm

BRAZO DUCHA A TECHO / CEILING SHOWER ARM

Diámetro
Diameter



LATÓN
BRASS



Star

Cod. Barras / Bar Code	Ref.	Color / Colour	U/
8410787025042	22080414		4 24,99€

Brazo de ducha a techo - Longitud: 20 cm - Ø 25 mm - Enlace a techo de 1/2" - Enlace a rociador de 1/2".

Ceiling shower arm - Length: 20 cm - Ø 25 mm - 1/2" connection to the ceiling - 1/2" connection to the overhead shower.

Caja - Box: 245 x 45 x 45 mm

Difusores / Shower heads

6 FUNCIONES / 6 FUNCTIONS

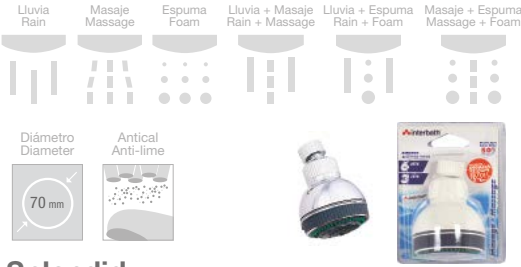

Splendid

Cod. Barras / Bar Code	Ref.	Color / Colour	U/
8410787004542	17020302	○	4 10,24€
8410787004535	17020314	○	4 11,94€

Difusor 6 funciones - Anticalcáreo - Ahorra agua
6 functions showerhead - Anti-lime system - Saves water

Blister: 112 x 143 x 80 mm

3 FUNCIONES / 3 FUNCTIONS



Tornado

Cod. Barras / Bar Code	Ref.	Color / Colour	U/
8410787007994	01107902	○	4 7,50€
8410787008007	01107914	○	4 8,83€

Difusor de 3 funciones - Ahorra agua.
3 functions showerhead - Saves water

Blister: 112 x 143 x 70 mm

1 FUNCION ANTICAL / 1 FUNCTION ANTI-LIME

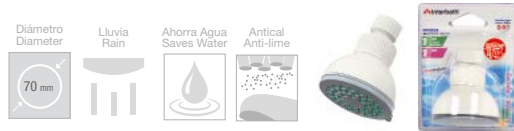

Rain

Cod. Barras / Bar Code	Ref.	Color / Colour	U/
8410787005662	17020202	○	4 6,30€
8410787002692	17020214	○	4 7,77€

Difusor de 1 función - Anticalcáreo - Ahorra agua.
1 function showerhead - Anti-lime system - Saves water.

Blister: 112 x 143 x 80 mm

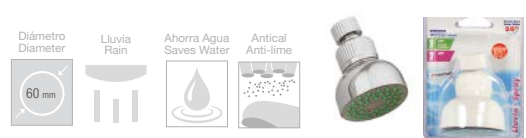

Dynamic

Cod. Barras / Bar Code	Ref.	Color / Colour	U/
8410787008014	01107602	○	4 5,14€
8410787008021	01107614	○	4 6,85€

Difusor de 1 función - Anticalcáreo - Ahorra agua.
1 function showerhead - Anti-lime system - Saves water.

Blister: 112 x 143 x 70 mm

1 FUNCION / 1 FUNCTION



Energy

Cod. Barras / Bar Code	Ref.	Color / Colour	U/
8410787005648	17020402	○	4 5,19€
8410787005655	17020414	○	4 6,93€

Difusor de 1 función - Ahorra agua.
1 function showerhead - Saves water.

Blister: 112 x 143 x 70 mm



Impact

Cod. Barras / Bar Code	Ref.	Color / Colour	U/
8410787007970	01107802	○	4 5,08€
8410787007987	01107814	○	4 6,85€

Difusor de 1 función - Ahorra agua.
1 function showerhead - Saves water.

Blister: 112 x 143 x 70 mm



Lasser

Cod. Barras / Bar Code	Ref.	Color / Colour	U/
8410787023796	17040414	○	2 41,00€

Barra Mural deslizante con tubo de sección oval - Jabonera reversible - Longitud 80 cm - Incluye Kit de tacos y tornillos.
 Slide bar for handshowers - oval section tube - Reversible soap dish - Length: 80 cm - Kit of screws and plugs.

Blister: 150 x 810 x 100 mm



Placet

Cod. Barras / Bar Code	Ref.	Color / Colour	U/
8410787010383	17040314	○	2 33,26€

Barra mural 70 cm para mango de ducha - Con cursor deslizante autobloqueo - Jabonera - Longitud: 70 cm - Diámetro: 28 mm - Kit de tacos y tornillos.

Slide bar for handshower with an autoblock clamp bracket adjustable in height - Soap Dish - Length: 70 cm - Diameter: 28 mm - Kit of screws and plugs.

Blister: 150 x 810 x 100 mm



Practika

Cod. Barras / Bar Code	Ref.	Color / Colour	U/
8410787025394	17040514	○	4 21,32€

Barra mural deslizante con el terminal superior pasante - Longitud total: 75 cm - Diámetro del tubo: 20 mm - Kit de tacos y tornillos.
 Sliding bar with upper fixing walls - Total length: 75 cm - Tube diameter: 20 mm - Kit of screws and plugs.

Blister: 135 x 830 x 45 mm



Excalibur

Cod. Barras / Bar Code	Ref.	Color / Colour	U/
8410787005006	17040102	○	4 10,82€
8410787002715	17040114	○	4 14,95€

Barra mural para mango de ducha - Longitud: 60 cm - Diámetro: 20 mm - Kit de tacos y tornillos.

Slide bar for handshower Length: 70 cm - Diameter: 20 mm - Kit of screws and plugs.

Blister: 132 x 700 x 45 mm



Techno

Cod. Barras / Bar Code	Ref.	Color / Colour	U/
8410787021471	17011002	○	4 4,41€
8410787021488	17011014	○	4 6,00€

Soporte orientable y articulado para mango de ducha - El mango de ducha se puede mover en diferente ángulo y dirección - Kit de tacos y tornillos.

Adjustable handshower support - The handshower can be adjusted for angle and direction - Kit of screws and plugs.

Blister: 112 x 143 x 55 mm



Superform

Cod. Barras / Bar Code	Ref.	Color / Colour	U/
8410787003354	17010502	○	4 3,18€
8410787002661	17010501	●	4 3,18€
8410787002678	17010514	○	4 4,81€

Soporte orientable y articulado para mango de ducha - El mango de ducha se puede mover en diferente ángulo y dirección - Kit de tacos y tornillos.

Adjustable handshower support - The handshower can be adjusted for angle and direction - Kit of screws and plugs.

Blister: 112 x 143 x 55 mm

FIJOS / FIXED



Max

Cod. Barras / Bar Code	Ref.	Color / Colour	U/
8410787012073	17010914	○	4 4,20€

Soporte para mango de ducha - Kit de tacos y tornillos.

Handshower support - Kit of screws and plugs.

Blister: 112 x 143 x 55 mm



Practik

Cod. Barras / Bar Code	Ref.	Color / Colour	U/
8410787007147	17010002	○	4 1,95€
8410787007130	17010001	●	4 1,95€
8410787007154	17010014	○	4 2,87€

Soporte para mango de ducha - Kit de tacos y tornillos.

Handshower support - Kit of screws and plugs.

Blister: 112 x 143 x 30 mm



Avanti

Cod. Barras / Bar Code	Ref.	Color / Colour	U/
8410787007185	17010702	○	4 1,84€
8410787007178	17010701	●	4 1,84€
8410787026254	17010714	○	4 2,41€

Soporte para mango de ducha - Kit de tacos y tornillos.

Handshower support - Kit of screws and plugs.

Blister: 112 x 143 x 30 mm

Ahorra Agua
Saves Water



Ducha - Stop

Cod. Barras / Bar Code	Ref.	Color / Colour	U/
8410787007390	22040314	○	8 5,36€

Válvula de apertura y cierre - Para instalar en mangos y difusores de ducha - Fabricada en latón.

Shower stopper - To be installed on handshowers and shower heads - Made of brass.

Blister: 112 x 143 x 30 mm



Codo

Cod. Barras / Bar Code	Ref.	Color / Colour	U/
8410787020856	17020102	○	8 1,74€
8410787020849	17020101	●	8 1,74€
8410787003361	17020114	○	8 2,36€

Conexión para mangos de ducha a flexibles.

Adaptor elbow for handshowers to flexible hoses.

Blister: 112 x 143 x 30 mm



Rótula

Cod. Barras / Bar Code	Ref.	Color / Colour	U/
8410787002623	17010114	○	4 5,64€

Orientable y articulado para mangos con codo - Kit de tacos y tornillos.

Adjustable in angle and direction for handshowers with adaptor elbow - Kit of screws and plugs.

Blister: 112 x 143 x 55 mm



Rótula con toma

Cod. Barras / Bar Code	Ref.	Color / Colour	U/
8410787002630	17010214	○	4 17,85€

Soporte metálico orientable para mangos de ducha con codo - Fabricada en latón.

Metallic adjustable support for handshowers with adaptor elbow - Made of brass.

Blister: 112 x 143 x 55 mm

ESTÁNDAR / STANDARD



Aluflex

Cod. Barras / Bar Code	Ref.	Medida / Size	Color / Colour	U/	
------------------------	------	---------------	----------------	----	--

8410787020825 **10110102** 1,75 m 6 **14,33€**

Flexible de metal en acabado cromo/mate y blanco. 1/2"x1/2".

Metallic shower hose with white and matt chrome finishing. 1/2"x1/2".

Blister: 220 x 290 x 30 mm



Cromflex

Cod. Barras / Bar Code	Ref.	Medida / Size	Color / Colour	U/	
------------------------	------	---------------	----------------	----	--

8410787002166 **10010114** 1,50 m 6 **8,88€**

8410787018778 **10010314** 1,75 m 6 **9,89€**

8410787002173 **10010214** 2 m 6 **10,48€**

Flexible de metal. 1/2"x1/2".

Metallic shower hose. 1/2"x1/2".

Blister: 220 x 290 x 30 mm

REFORZADOS / REINFORCED



Superflex

Cod. Barras / Bar Code	Ref.	Medida / Size	Color / Colour	U/	
------------------------	------	---------------	----------------	----	--

8410787021570 **10011514** 1,50 m 6 **11,34€**

8410787002180 **10011014** 1,75 m 6 **12,29€**

8410787018556 **10011114** 2 m 6 **13,12€**

Flexible de metal reforzado, con sistema de doble engatillado. 1/2"x1/2".

Metallic shower hose with double agraffed system. 1/2"x1/2".

Blister: 220 x 290 x 30 mm



Superflex Plus

Cod. Barras / Bar Code	Ref.	Medida / Size	Color / Colour	U/	
------------------------	------	---------------	----------------	----	--

8410787021587 **10011814** 1,50 m 6 **12,81€**

8410787021594 **10011914** 1,75 m 6 **13,76€**

8410787021600 **10012014** 2 m 6 **14,50€**

Flexible de metal reforzado, con sistema de doble engatillado y terminal cónico antitorsión. 1/2"x1/2".

Metallic shower hose with double agraffed system and anti-twist conical nut. 1/2"x1/2".

Blister: 220 x 290 x 30 mm



Longflex

Cod. Barras / Bar Code	Ref.	Medida / Size	Color / Colour	U/	
------------------------	------	---------------	----------------	----	--

8410787018525 **10070114** **→ 2 m** 6 **7,27€**

Flexible de metal reforzado, con medida extensible hasta 2 m. 1/2"x1/2".

Reinforced shower hose with extensible size up to 2 m. 1/2"x1/2".

Blister: 220 x 290 x 30 mm

Plásticos / Plastic

ESTÁNDAR / STANDARD



Megaflex

Cod. Barras / Bar Code	Ref.	Medida / Size	Color / Colour	U/	
8410787005808	10020102	1,50 m	○	6	5,38€
8410787002197	10020101	1,50 m	○	6	5,38€
8410787002210	10020202	2 m	○	6	6,00€
8410787002203	10020201	2 m	○	6	6,00€

Flexible de Plástico. 1/2"x1/2".

Plastic shower hose. 1/2"x1/2".

Blister: 220 x 290 x 30 mm



Megaflex 2

Cod. Barras / Bar Code	Ref.	Medida / Size	Color / Colour	U/	
8410787018808	10080014	1,75 m	○	6	7,02€
8410787018815	10090014	2 m	○	6	7,58€

Flexible plástico con acabado cromo/transparente que se adapta tanto a los mangos cromados como a los blancos. 1/2"x1/2".

Chrome/transparent finishing plastic shower hose that combines perfectly with white and chrome handshowers. 1/2"x1/2".

Blister: 220 x 290 x 30 mm

REFORZADOS / REINFORCED



Ultraflex

Cod. Barras / Bar Code	Ref.	Medida / Size	Color / Colour	U/	
8410787018785	10022002	1,75 m	○	6	9,78€
8410787018792	10022014	1,75 m	○	6	9,96€
8410787002289	10021002	2 m	○	6	10,63€
8410787002296	10021014	2 m	○	6	11,08€

Flexible de plástico reforzado interiormente por hilos transversales de nylon. 1/2"x1/2".

Plastic shower hose internally reinforced by the means of transversal threads of nylon. 1/2"x1/2".

Blister: 220 x 290 x 30 mm



Satinflex

Cod. Barras / Bar Code	Ref.	Medida / Size	Color / Colour	U/	
8410787019041	10100219	1,75 m	Ⓜ	6	17,32€
8410787019058	10100319	2 m	Ⓜ	6	18,96€

Flexible de plástico reforzado interiormente por hilos transversales de nylon. Superficie lisa en acabado cromo / mate. 1/2"x1/2".

Plastic shower hose internally reinforced by the means of transversal threads of nylon. Matt chrome smooth surface. 1/2"x1/2".

Blister: 220 x 290 x 30 mm

Barras de Cortina / Curtain Rods

CURVAS / CURVED

MÁS ESPACIO, MÁS CONFORT
MORE SPACE, MORE COMFORT



ADECUADA PARA LA INSTALACIÓN EN HOTELES / SUITABLE FOR INSTALLATION IN HOTELS

Habitat

La barra de cortina para la bañera Habitat de Interbath por su nuevo y único diseño **permite ampliar el espacio dentro de la bañera hasta 30 cm.**, proporcionando al usuario más espacio, más facilidad de movimientos y en definitiva más confort. Sus soportes a pared articulados facilitan la instalación de la barra en diferentes ángulos proporcionando a su vez gran resistencia, no siendo necesario el uso de elementos de sujeción a techo, salvo en los siguientes casos: Máxima extensión de la barra. Uso de cortinas de material pesado. Instalaciones de uso público. **MUY FÁCIL DE INSTALAR.** Medida extensible de 114 a 200 cm. Habitat se adapta a la mayoría de las bañeras disponibles en el mercado. Soportes incluidos.

The curtain rod of Interbath Habitat for the bathtub allows, by its new and unique design, to expand the space within the bathtub up to 30 cm., providing to the user more space, more facility of movements and really more comfort. Its articulated wall supports facilitate the installation of the rod in different angles, providing great resistance, without being necessary the use of ceiling supporting elements unless recommended as below: Total extension of the bar. Use of very heavy curtain rods. Public use installations. **VERY EASY TO INSTALL.** Extensible size from 114 to 200 cm. Habitat can be adapted to most of the bathtubs in the market. Supports are included.

Medida extensible de 114 cm a 200 cm. Extensible size from 114 to 200 cm.



Habitat

Cod. Barras / Bar Code	Ref.	Medida / Size	Color / Colour	U	Kit
8410787026148	04060102	114/200 cm	○	4	29,04€
8410787026155	04060109	114/200 cm	●	4	37,23€

8410787026148 04060102 114/200 cm ○ 4 29,04€

8410787026155 04060109 114/200 cm ● 4 37,23€

Barra curva extensible para bañera - Medida extensible de 114 a 200 cm - Diámetro del tubo 20 mm - Incluye Kit de tacos y tornillos.

Curtain rod for bath tub - Extensible size from 114 to 200 cm -

Articulated supports - Tube diameter 20 mm - Kit of screws and plugs.

Blister: 140 x 1120 x 30 mm

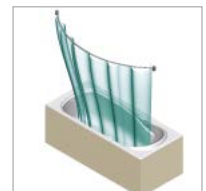

Roundbath

Gama de barras de cortina fijas que se adaptan a los nuevos modelos de platos de ducha con un lado curvo. Medidas: 80 x 80 cm. 90 x 90 cm y 100 x 100 cm. Las nuevas Roundbath están fabricadas en tubo de aluminio de Ø 20 mm. Con soportes a pared y piezas de unión en ABS. Soportes y cadena de sujeción a techo incluidos.

A range of fixed curtain rods that can be adapted to the most of the new angled one side curved shower plates: Sizes: 80 x 80 cm, 90 x 90 cm and 100 x 100 cm. Roundbath is made of aluminum tube of Ø 20 mm. with wall supports and assembly pieces made of ABS. Includes wall supports and ceiling chain support.



Roundbath

Cod. Barras / Bar Code	Ref.	Medida / Size	Color / Colour	U	
8410787026162	04070102	80x80 cm	○	4	22,19€
8410787026179	04070109	80x80 cm	○	4	27,38€
8410787026186	04070202	90x90 cm	○	4	22,06€
8410787026193	04070209	90x90 cm	○	4	27,26€
8410787026209	04070302	100x100 cm	○	4	22,45€
8410787026216	04070309	100x100 cm	○	4	27,19€

Barra curva para plato de ducha semicircular - Diámetro del tubo 20 mm - Varias medidas - Incluye Kit de tacos, tornillos y cadena.

Curtain rod for semicircular shower plate - Tube diameter 20 mm - Several sizes - Kit of screws and plugs.

Blister: 140 x 1120 x 30 mm





Bathform

Cod. Barras / Bar Code	Ref.	Medida / Size	Color / Colour	U/ 
8410787000728	04020102	70x114/190 cm	○	4 21,42€
8410787000797	04020109	70x114/190 cm	○	4 26,12€

Barra curva extensible para cortina de baño - Medidas: Lado fijo: 70 cm - Lado extensible: De 114 a 190 cm - Diámetro del tubo 20 mm - Soportes incluidos.

Extensible curved curtain rod - Sizes: Fixed side: 70cm - Extensible side: From 114 to 190cm - Tube diameter 20 mm - Supports are included.

 Blister: 140 x 1120 x 30 mm



Bathplus

Cod. Barras / Bar Code	Ref.	Medida / Size	Color / Colour	U/ 
8410787000872	04020502	70x70 cm	○	4 15,86€
8410787000889	04020509	70x70 cm	○	4 20,46€
8410787019065	04020602	80x80 cm	○	4 16,79€
8410787027107	04020609	80x80 cm	○	4 20,50€
8410787000834	04020302	100x70 cm	○	4 16,89€
8410787000841	04020309	100x70 cm	○	4 21,60€

Gama de barras curvas fijas para cortina de baño - Diámetro del tubo 20 mm - Soportes incluidos.

Range of fixed curved curtain rods - Tube diameter 20 mm - Supports are included.

 Blister: 140 x 1120 x 30 mm

Barras de Cortina / Curtain Rods

RECTAS / STRAIGHT

Springbath

Gama de barras extensibles para cortina de baño. No necesitan tornillos ni taladros para su instalación. Se fijan a las paredes sin dañarlas. Gracias a su sistema interior de muelle y su botón autobloqueo la barra se sujeta sólidamente a las paredes. Medidas: De 80 cm a 125 cm. De 105 cm a 170 cm. De 150 cm a 215 cm.

Straight extensible shower curtain rods. No need for screws or drilling for installation. They fix without damaging the wall surfaces. Sizes: From 80 cm to 125 cm. From 105 cm to 170 cm. From 150 cm to 215 cm.



Springbath

Cod. Barras / Bar Code	Ref.	Medida / Size	Color / Colour	U/	Box
8410787000520	04010102	80/125 cm	○	12	13,75€
8410787000537	04010109	80/125 cm	●	12	14,63€
8410787000544	04010202	105/170 cm	○	12	17,51€
8410787000612	04010209	105/170 cm	●	12	18,02€
8410787000636	04010302	150/215 cm	○	8	18,95€
8410787000704	04010309	150/215 cm	●	8	19,57€

Barra recta extensible para cortina de baño - Diámetro del tubo 20 mm - No necesita tornillos ni taladros para su instalación.

Straight extensible shower curtain rod - Tube diameter 20 mm - No need for screws or drilling for installation.

Blister: 100 x 1120 x 30 mm



CURVAS / CURVED

RECTAS / STRAIGHT



Basic Curva

Basic Recta

Cod. Barras / Bar Code	Ref.	Medida / Size	Color / Colour	U/	Box
8410787017528	04030302	70x114/190 cm	○	4	17,88€

Barra curva extensible para cortina de baño - Lado fijo: 70 cm. Lado extensible: De 114 a 190 cm - Diámetro del tubo 20 mm - Soportes incluidos.

Extensible curved curtain rod - Fixed side: 70 cm. Extensible side: From 114 to 190 cm - Tube diameter 20 mm - Supports are included.

Skin Pack 160 x 1120 x 30 mm

Cod. Barras / Bar Code	Ref.	Medida / Size	Color / Colour	U/	Box
8410787017504	04030102	100/170 cm	○	12	12,05€
8410787017511	04030202	150/210 cm	○	8	14,83€

Barra recta extensible para cortina de baño - Diámetro del tubo 20 mm - No necesita tornillos ni taladros para su instalación.

Straight extensible shower curtain rod - Tube diameter 20 mm - No need for screws or drilling for installation.

Skin Pack: 84 x 1120 x 30 mm

RECTO / STRAIGHT

MÚLTIPLE

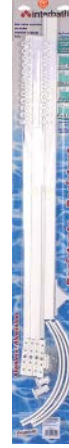

Rielbath

Cod. Barras / Bar Code	Ref.	Medida / Size	Color / Colour	U/	U/
8410787001329	05010102	250 cm	○	12	19,98€

Gama de rieles para cortina de baño - Incluyen todas las piezas para su instalación - Medidas: Recto: Hasta 250 cm.

Shower curtain rails. All pieces for installation are included - Sizes: Straight: Up to 250 cm.

Blister Pack: 160 x 1120 x 30 mm

Multiform

Cod. Barras / Bar Code	Ref.	Medida / Size	Color / Colour	U/	U/
8410787003545	05030102	90/190 cm	○	10	27,73€

Riel con cuatro opciones diferentes de montaje - Incluye todas las piezas necesarias para su instalación.

Four assembly options shower curtain rail - All pieces for installation are included.

Blister Pack: 160 x 1120 x 30 mm

ACCESORIOS / ACCESSORIES

Steff



Cod. Barras / Bar Code	Ref.	Color / Colour	U/	U/
8410787001367	06010102	○	8	2,05€
8410787001435	06010111	⊗	8	3,19€

Anillos para cortinas de baño. Envase con 15 unidades.
Shower curtain rings. Set of 15 units.

Blister: 112 x 143 x 55 mm

Cadena



Cod. Barras / Bar Code	Ref.	Color / Colour	U/	U/
8410787002654	17010414	○	8	3,50€

Cadena de sujeción para barra de cortina.
Chain for shower curtain rod.

Blister: 112 x 143 x 55 mm

Soportes



Cod. Barras / Bar Code	Ref.	Color / Colour	U/	U/
8410787002647	17010314	○	4	3,97€
8410787027084	17010309	○	4	5,25€

Juego de 2 soportes para barra de cortina - Kit de tacos y tornillos.
2 supports for shower curtain rod - Kit of screws and plugs.

Blister: 112 x 143 x 55 mm

Menaje para el Baño / Bathroom Household

CUBOS PARA BAÑO / BATHROOM BASKETS



Bayben

Cod. Barras / Bar Code	Ref.	Color / Colour	U/	
8410787002500	13010102	○	2	11,03€
8410787027695	13010104	●	2	11,85€
8410787027701	13010105	●	2	11,85€
8410787027718	13010106	●	2	11,85€
8410787027725	13010107	●	2	11,85€

Cubo de baño de 9 litros de capacidad - Tapadera basculante - Medida: 22 cm x 14 cm x 38 cm - Nueva gama de colores Spring.

9 liters capacity bathroom basket - Swing-shut top - Size: 22 cm x 14 cm x 38 cm - New Spring colour range.

Bolsa - Bag: 380 x 220 x 140 mm

PORTAESCOBILLAS / TOILET BRUSH SETS



Nilo

Cod. Barras / Bar Code	Ref.	Color / Colour	U/	
8410787002401	11030102	○	4	4,28€
8410787027657	11030104	●	4	5,75€
8410787027664	11030105	●	4	5,75€
8410787027671	11030106	●	4	5,89€
8410787027688	11030107	●	4	5,89€

Portaescobillas de baño fabricados en material plástico - La escobilla también se puede adquirir por separado - Nueva gama de colores Spring.

Plastic toilet brush sets - The toilet brush is also available separately - Made of plastic - New Spring colour range.

Bolsa - Bag: 350 x 120 x 120 mm



Rapid

Cod. Barras / Bar Code	Ref.	Color / Colour	U/	
8410787002722	17050102	○	12	4,26€

Repuesto escobillas WC.

Toilet brush replacement.

Bolsa con solapa - Bag with hanger: 490 x 150 x 80 mm



Korinto

Cod. Barras / Bar Code	Ref.	Color / Colour	U/	
8410787002302	11010102	○	4	6,12€

Portaescobillas de baño fabricados en material plástico - La escobilla también se puede adquirir por separado.

Plastic toilet brush sets - The toilet brush replacement is also available separately - Made of plastic material.

Bolsa - Bag: 350 x 120 x 120 mm

Mix

Conjunto que incluye cubo de baño de 9 litros con tapadera basculante y portaescobillas de baño. El conjunto se sirve con el portaescobillas en el interior del cubo. Nueva gama de colores Spring.

9 liters swing-shut top bathroom basket and toilet brush set. Supplied with the toilet brush set inside the basket. New Spring colour range.



Mix

Cod. Barras / Bar Code	Ref.	Color / Colour	U/	
8410787012721	13019802	○	10	14,11€
8410787027732	13019804	●	10	15,89€
8410787027749	13019805	●	10	15,89€
8410787027756	13019806	●	10	15,89€
8410787027763	13019807	●	10	

Cubo de baño de 9 litros con tapadera basculante - Portaescobillas de baño - Fabricados en material plástico.

Swing-shut top bathroom basket - Toilet brush set - Made of plastic.

Box Pallet: 900 x 600 x 400 mm

Mix Multicolor

Cod. Barras / Bar Code	Ref.	Color / Colour	U/	
8410787028142	13019899		1	148,23€
2 Mix blanco, 2 Mix verde, 2 Mix azul, 2 Mix naranja y 2 Mix rojo.				
2 White mix, 2 Green mix, 2 Blue mix, 2 Orange mix and 2 Red mix.				
Box Pallet: 900 x 600 x 400 mm				





Abatibles / Folding

Asideros abatibles para pared adecuados tanto para uso privado como para colectividades. Fabricados en acero inoxidable (AISI 304). Su diámetro de tubo de 32 mm proporciona más superficie de agarre y un alto nivel de seguridad. Gran durabilidad y resistencia. Kit de tacos y tornillos.

Wall-mounted folding grab bars suitable for both, private and public places. Made of stainless steel (AISI 304). Tube diameter of 32 mm provides more grip surface and a high level of security. Great durability and strength. Kit of screws and plugs.

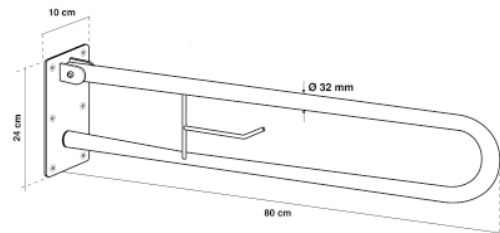
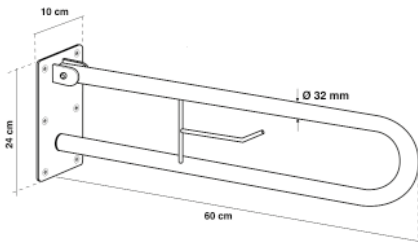

Asideros / Grab bars

DIÁMETRO 32 MM / DIAMETER 32 MM



60 cm

Cod. Barras / Bar Code	Ref.	Color / Colour	U/ 
8410787028494	20001014	○	1 132,30€

Largo total: 60 cm. - Incluye portarrollo.

Total Length: 60 cm. - Paper holder included.

 Caja - Box: 680 x 245 x 105 mm

80 cm

Cod. Barras / Bar Code	Ref.	Color / Colour	U/ 
8410787028517	20001114	○	1 140,70€

Largo total: 80 cm. - Incluye portarrollo.

Total Length: 80 cm. - Paper holder included.

 Caja - Box: 880 x 245 x 105 mm



Rectos estriados / Straight knurled

Asidero recto con **superficie estriada antideslizante** adecuados tanto para uso privado como para colectividades. Fabricados en acero inoxidable (AISI 304). Su diámetro de tubo de 32 mm proporciona más superficie de agarre y un alto nivel de seguridad. Gran durabilidad y resistencia. Kit de tacos y tornillos.

Straight grab bar **with non-slip knurled surface** suitable for both, private and public places. Made of stainless steel (AISI 304). Tube diameter of 32 mm provides more grip surface and a high level of security. Great durability and strength. Kit of screws and plugs.



Con superficie estriada antideslizante / With non-slip knurled surface

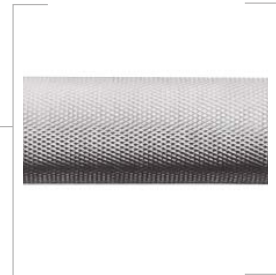
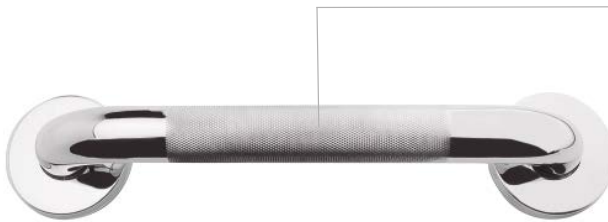

RESISTENCIA Y DURABILIDAD
RESISTANCE AND DURABILITY
RÉSISTANCE ET LONGÉVITÉ
RESISTÊNCIA E DURABILIDADE

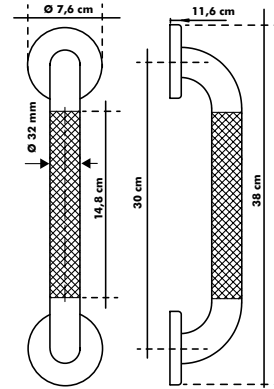

38 cm

Cod. Barras / Bar Code	Ref.	Color / Colour	U/
8410787034570	20001614		2 34,60€

Largo total: 38 cm. - Largo entre ejes: 30 cm.

Total Length: 38 cm. - Axel distance: 30 cm.

Caja - Box: 440 x 90 x 90 mm

* Consultar disponibilidad - Check availability

Asideros / Grab bars

DIÁMETRO 32 MM / DIAMETER 32 MM

Rectos / Straight

Asideros rectos adecuados tanto para uso privado como para colectividades. Fabricados en acero inoxidable (AISI 304). Su diámetro de tubo de 32 mm proporciona más superficie de agarre y un alto nivel de seguridad. Gran durabilidad y resistencia. Kit de tacos y tornillos.

Straight grab bars suitable for both, private and public places. Made of stainless steel (AISI 304). Tube diameter of 32 mm provides more grip surface and a high level of security. Great durability and strength. Kit of screws and plugs.

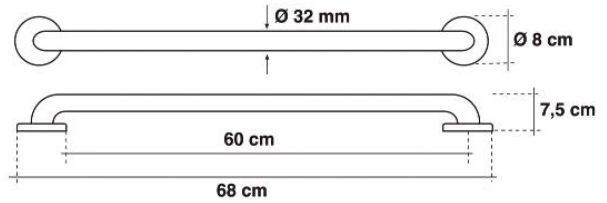
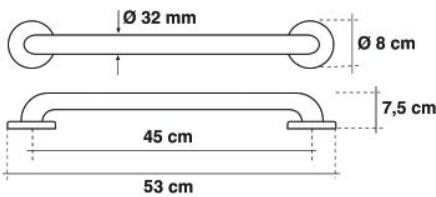

53 cm

Cod. Barras / Bar Code	Ref.	Color / Colour	U/
------------------------	------	----------------	----

8410787027497 **20000414** ○ 2 **39,06€**
 Largo total: 53 cm. - Largo entre ejes: 45 cm.
 Total Length: 53 cm. - Axel distance: 45 cm.

Caja - Box: 585 x 90 x 90 mm



68 cm

Cod. Barras / Bar Code	Ref.	Color / Colour	U/
------------------------	------	----------------	----

8410787027510 **20000514** ○ 2 **43,24€**
 Largo total: 68 cm. - Largo entre ejes: 60 cm.
 Total Length: 68 cm. - Axel distance: 60 cm.

Caja - Box: 740 x 90 x 90 mm

Asideros / Grab bars

DIÁMETRO 25 MM / DIAMETER 25 MM

Rectos / Straight

Asideros fabricados en acero inoxidable (AISI 304). Kit de tacos y tornillos. Medida: 30 o 50 cm. Ø 25 mm

Stainless steel (AISI 304) grab bars. Kit of screws and plugs. Size: 30 or 50 cm. Ø 25 mm.

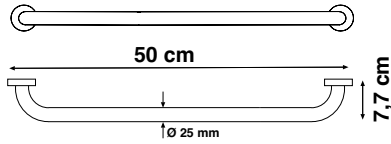
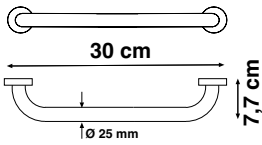

30 cm

Cod. Barras / Bar Code	Ref.	Color / Colour	U/	Icon
8410787025998	20000002	○	6	23,43€
8410787025462	20000014	○	6	21,76€

Asideros de acero inoxidable - Kit de tacos y tornillos - Medida: 30 cm Ø 25 mm.

Stainless steel grab bars - Kit of screws and plugs - Size: 30 cm Ø 25 mm.

Blister: 410 x 135 x 65 mm

50 cm

Cod. Barras / Bar Code	Ref.	Color / Colour	U/	Icon
8410787025981	20000102	○	4	27,67€
8410787025479	20000114	○	4	24,55€

Asideros de acero inoxidable - Kit de tacos y tornillos - Medida: 50 cm Ø 25 mm

Stainless steel grab bars - Kit of screws and plugs - Size: 50 cm Ø 25 mm.

Blister: 615 x 135 x 65 mm

Asideros / Grab bars

DIÁMETRO 25 MM / DIAMETER 25 MM

Angular / Angled

Asidero fabricado en acero inoxidable (AISI 304). Kit de tacos y tornillos. Medida: 46 cm. Ø 25 mm

Stainless steel (AISI 304) grab bars. Kit of screws and plugs. Size: 46 cm. Ø 25 mm.

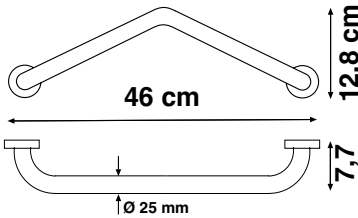

46 cm

Cod. Barras / Bar Code	Ref.	Color / Colour	U/
8410787025486	20000214	○	1 29,63€

Asidero de acero inoxidable. Kit de tacos y tornillos - Medida: 46 cm. Ø 25 mm

Stainless steel grab bar. Kit of screws and plugs - Size: 46 cm. Ø 25 mm.

Blister: 580 x 175 x 90 mm

Angular con jabonera / Angled with soap dish

Asidero fabricado en acero inoxidable (AISI 304). Jabonera reversible. Kit de tacos y tornillos. Medida: 45 cm. Ø 25 mm

Stainless steel (AISI 304) grab bars. Reversible soap dish. Kit of screws and plugs. Size: 45 cm. Ø 25 mm.

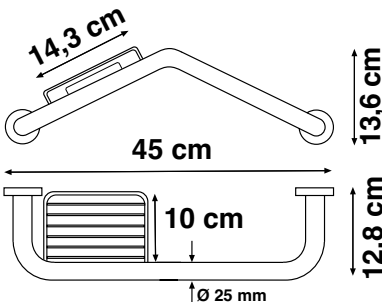

45 cm

Cod. Barras / Bar Code	Ref.	Color / Colour	U/
8410787025967	20000302	○	1 32,44€
8410787025493	20000314	○	1 33,22€

Asidero de acero inoxidable - Jabonera reversible. Kit de tacos y tornillos - Medida: 45 cm. Ø 25 mm

Stainless steel grab bar - Reversible soap dish. Kit of screws and plugs - Size: 45 cm. Ø 25 mm.

Blister: 580 x 175 x 135 mm



Palermo

Cod. Barras / Bar Code	Ref.	Color / Colour	U/ 
8410787025554	20000802	○	2 313,07€

Asiento abatible - Fabricado en material plástico con refuerzo interior de acero inoxidable - Resistencia máxima 150 kg. Kit de tacos y tornillos.

Folding seat with back. Seat made of plastic with stainless steel internal holder - Maximum weight: 150 kg. Kit of screws and plugs.

Caja - Box: 435 x 370 x 85 mm

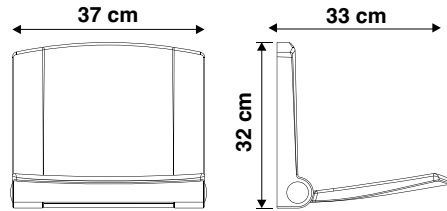

Rodas

Cod. Barras / Bar Code	Ref.	Color / Colour	U/ 
8410787025530	20000602	○	2 173,21€

Asiento abatible - Material plástico con refuerzo interior de acero inoxidable - Resistencia máxima 150 kg - Kit de tacos y tornillos.

Folding seat with back - Seat made of plastic with stainless steel internal holder - Maximum weight: 150 Kg - Kit of screws and plugs.

Caja - Box: 475 x 365 x 70 mm

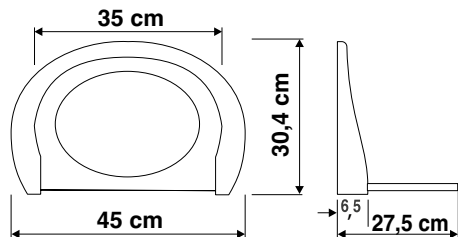

Mónaco plus

Está equipado con dos patas que proporcionan mayor resistencia y estabilidad. Las patas, fabricadas en aluminio anodizado, son extensibles proporcionando un rango de altura de 43 a 55 cm. Kit de tacos y tornillos.

It is equipped with two legs that provide greater strength and stability. The legs, made of anodized aluminum, are extensible and therefore provide a height range from 43 to 55 cm. Kit of screws and plugs.

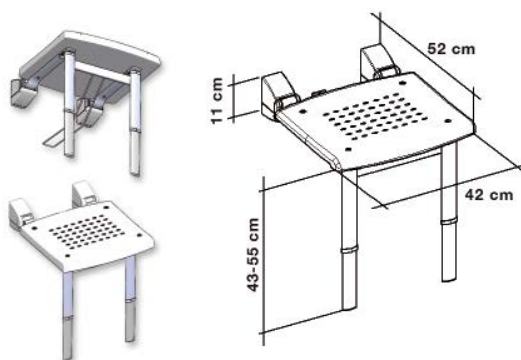

Mónaco plus

Cod. Barras / Bar Code	Ref.	Color / Colour	U/ 	
8410787027480	20000902	○	2	243,81€

Asiento abatible con patas - Fabricado en material plástico con refuerzo interior de acero inoxidable - Resistencia máxima 150 kg - Kit de tacos y tornillos.

Folding seat with legs - Seat made of plastic with stainless steel internal holder - Maximum weight: 150 kg - Kit of screws and plugs.

 Caja - Box: 555 x 430 x 155 mm



Corfú

Cod. Barras / Bar Code	Ref.	Color / Colour	U/ 	
8410787025509	20000402	○	2	50,42€
8410787025516	20000423	●	2	57,24€

Asiento abatible de lamas. Estructura de aluminio lacado blanco. Lamas de plástico o de madera tropical resistente al agua - Resistencia máxima 130 kg - Kit de tacos y tornillos.

Slat folding seat - Made of painted aluminium frame with plastic or wooden slats - Maximum weight: 130 kg - Kit of screws and plugs.

 Caja - Box: 360 x 325 x 55 mm

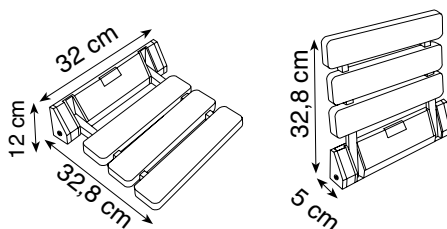

Ponny

Gama de asientos para el interior de la ducha. Está compuesta por tres modelos con y sin respaldo equipados con patas de aluminio y tapones de goma que les confieren una gran estabilidad. Las patas, extensibles, disponen de 8 puntos de anclaje proporcionando un rango de altura variable aproximado entre 35 y 55 cm. .

Range of seats to place inside the shower. It consists of three models with and without back, aluminium legs fitted with rubber stoppers and aluminium that give them greater stability. The legs, that are extendible, have 8 anchor points providing a variable height range approximately between 35 and 55 cm.



Con orificios que permiten desalojar el agua.
With holes to evacuate water.



Ponny Back

Cod. Barras / Bar Code	Ref.	Color / Colour	U/
8410787034303	20001402	○	1 67,09€

Taburete con respaldo para el interior de la ducha - Fabricado en material plástico antideslizante - Con patas extensibles de aluminio y tapones de goma antideslizante - Resistencia máxima 130 kg. - Incluye todas las piezas necesarias para su instalación.

Stool with back for use inside the shower - Made of anti-slip plastic - With aluminum extendible legs and rubber non slip stoppers - 130 kg Maximum resistance. - Includes all pieces, required for installation.

Caja - Box: 580 x 340 x 140 mm



Con orificios que permiten desalojar el agua.
With holes to evacuate water.



Ponny

Cod. Barras / Bar Code	Ref.	Color / Colour	U/ 
8410787034297	20001302	○	1 52,39€

Taburete para el interior de la ducha - Fabricado en material plástico antideslizante - Con patas extensibles de aluminio y tapones de goma antideslizante - Resistencia máxima 130 kg. - Incluye todas las piezas necesarias para su instalación.

Stool for use inside the shower - Made of anti-slip plastic - With aluminum extensible legs and rubber non slip stoppers - 130 kg maximum resistance. - Includes all pieces required for installation.

 Caja - Box: 580 x 340 x 120 mm



Ponny Round

Cod. Barras / Bar Code	Ref.	Color / Colour	U/ 
8410787034532	20001502	○	1 49,66€

Taburete para el interior de la ducha - Fabricado en material plástico antideslizante - Con patas extensibles de aluminio y tapones de goma antideslizante - Resistencia máxima 130 kg. - Incluye todas las piezas necesarias para su instalación.

Stool for use inside the shower - Made of anti-slip plastic - With aluminum extensible legs and rubber non slip stoppers - 130 kg maximum resistance. - Includes all pieces required for installation.

 Caja - Box: 395 x 340 x 82,55 mm





Niza

Cod. Barras / Bar Code	Ref.	Color / Colour	U/	
8410787018686	19000102	○	5	32,45€

Tapa para W.C. - Medida: 37,5 x 45 cm - Fijaciones plásticas y tornillos metálicos.

Toilet seat - Size: 37,5 x 45 cm - Plastic fixations with metallic screws.

Caja - Box: 450 x 375 x 80 mm



Capri

Cod. Barras / Bar Code	Ref.	Color / Colour	U/	
8410787018709	19000302	○	7	17,77€

Tapa para W.C. - Medida: 37,5 x 46,5 cm - Fijaciones y tornillos plásticos.

Toilet seat - Size: 37,5 x 46,5 cm - Plastic fixations and screws.

Bolsa - Bag: 465 x 375 x 80 mm

Línea de riego con goteros integrados / Irrigation line with integrated drips

Dropkit

Pensado para ayudar a reducir el consumo de agua y aumentar la calidad y el rendimiento de su jardín, Dropkit es la manera más sencilla y rápida de obtener un lineal de riego.

Está compuesto por una tubería de 8 mm de diámetro y 25 m de longitud, con goteros integrados cada 20 cm.

Dropkit incluye además instrucciones de montaje y una serie de accesorios que le permitirán completar fácilmente su instalación.

Para obtener un óptimo resultado Dropkit opera con una presión de 2,0 bar.

Designed to reduce water consumption and increase your garden quality and performance Dropkit is the easier and faster way to install a drip Irrigation system.

It includes, 25 m of 8 mm diameter pipe with integrated drippers, every 20 cm.

Dropkit also includes assembly instructions and accessories that will allow you to make the drip installation.

For proper operation Dropkit request a working pressure of 2kg.

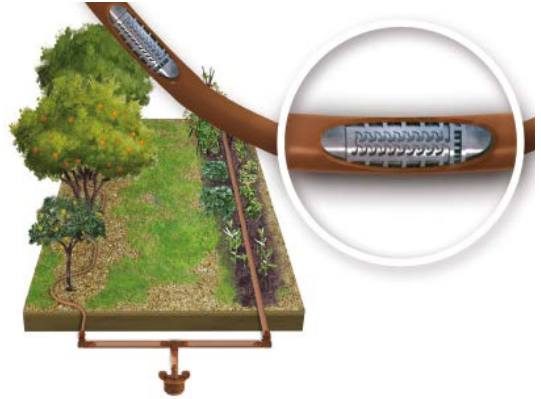

COMPONENTES / COMPONENTS



Adaptador rosca macho, 8 x 1/2" (1 und.)
Male thread adapter, 8 x 1/2" (1 pc.)



T 8 mm (2 und.)
8 mm T (2 pc.)



Línea de riego DropKit 8 mm (25 m)
DropKit irrigation line 8 mm (25 m)



Codo 90° 8 mm (2 und.)
Elbow 90° 8 mm (2 pc.)



Perforador Ø 3,7 mm
Driller Ø 3.7 mm



Enlace 8 mm (2 und.)
Link 8 mm (2 pc.)



Abrazadera cierre de línea (3 und.)
Clamp closure line (3 pc.)

Dropkit

Cod. Barras / Bar Code	Ref.	Color / Colour	U/ 
8410787030459	23010035		4

25,42€

Línea de riego de 8 mm con goteros integrados - componentes para la instalación - Perforador.

Irrigation line with integrated drips - components for installation - Driller.

 Caja - Box: 260 x 260 x 80 mm

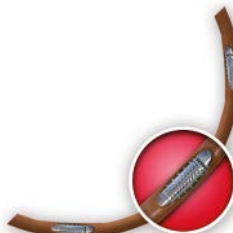



Fontanería / Plumbing products

<i>Lavabo - bidé / Washbasin - bidet</i>	94
<i>Fregadero / Sink</i>	97
<i>Plato de Ducha / Shower tray</i>	100
<i>Accesorios / Accessories</i>	101
<i>Cisterna / Cistern</i>	108

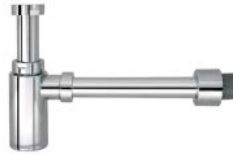

S-438

Cod. Barras / Bar Code	Ref.	Medida / Size	Color / Colour	U/	
8410787024359	88001586	1 1/4"xØ40 mm	○	6	36,84€
8410787024366	88001596	1 1/4"xØ40 mm	○	6	15,21€

Sifón botella con cuello extensible.
Bottle trap with extendable neck.

Blister: 185 x 295 x 55 mm



S-252

Cod. Barras / Bar Code	Ref.	Medida / Size	Color / Colour	U/	
8410787028135	88030004	1 1/4"xØ32 mm	○	6	37,98€

Sifón botella de latón, con cuello extensible. Salida horizontal acoplamiento y plafón.

Brass bottle trap, adjustable, horizontal outlet, coupling and bulk-head fitting.

Blister: 135 x 212 x 90 mm



S-181

Cod. Barras / Bar Code	Ref.	Medida / Size	Color / Colour	U/	
8410787024441	88006396	1 1/4"xØ32 mm	○	8	23,60€
8410787027954	88006398	1 1/2"xØ40 mm	○	8	25,27€

Sifón curvo con cuello extensible.
Curved trap with extendable neck.

Blister: 135 x 212 x 90 mm



S-182 / S-69

Cod. Barras / Bar Code	Ref.	Medida / Size	Color / Colour	U/	
8410787024403	88004096	1 1/4"xØ32 mm	○	8	23,60€
8410787024373	88004016	1 1/4"xØ32 mm	○	8	7,48€
8410787027787	88004098	1 1/2"xØ40 mm	○	8	24,35€
8410787024397	88004058	1 1/2"xØ40 mm	○	8	9,24€

Sifón botella extensible.
Bottle trap with extendable neck.

Blister: 114 x 191 x 70 mm



S-84

Cod. Barras / Bar Code	Ref.	Medida / Size	Color / Colour	U/	
8410787024380	88004036	1 1/4"xØ63 mm	○	8	12,54€

Sifón botella extensible con válvula, tapón y cadena.
 Bottle trap with extendable neck with outlet, plug and chain.

Blister: 135 x 212 x 90 mm



S-205

Cod. Barras / Bar Code	Ref.	Medida / Size	Color / Colour	U/	
8410787024410	88004126	1 1/4"xØ70 mm	○	8	42,01€

Sifón botella extensible con válvula, tapón, cadena y espiguilla.
 Bottle trap with extendable neck with outlet, plug and chain.

Blister: 135 x 212 x 90 mm



S-65

Cod. Barras / Bar Code	Ref.	Medida / Size	Color / Colour	U/	
8410787027770	88002128	1 1/2"xØ40 mm	○	8	9,46€

Sifón botella con cuello extensible y salida horizontal.
 Adjustable bottle trap, horizontal outlet, threaded.

Blister: 135 x 212 x 90 mm



S-11

Cod. Barras / Bar Code	Ref.	Medida / Size	Color / Colour	U/	
8410787027930	88001188	1 1/2"xØ63 mm	○	4	12,81€

Sifón vertical compacto con válvula tapón y cadena.
 Compact vertical, lavatory-bidet trap.

Blister: 158 x 245 x 71 mm



S-39

Cod. Barras / Bar Code	Ref.	Medida / Size	Color / Colour	U/	
8410787028111	88001268	1 1/2"xØ40 mm	○	4	10,16€

Sifón lavabo pedestal con cuello extensible.
 Adjustable vertical trap, with extendable neck.

Blister: 158 x 245 x 71 mm



S-451

Cod. Barras / Bar Code	Ref.	Medida / Size	Color / Colour	U/
8410787026100	88010056	1 1/4"xØ63 mm	○	10 30,17€

Válvula click clack - Válvula de desagüe con sistema de apertura y cierre con pulsador

Click clack waste outlet - Valve of water-drainage with pulsating open&close system.

Blister: 112 x 167 x 60 mm



S-183

Cod. Barras / Bar Code	Ref.	Medida / Size	Color / Colour	U/
8410787024496	88011156	1 1/4"xØ70 mm	○	10 29,40€
8410787027961	88011158	1 1/2"xØ70 mm	○	10 30,47€

Válvula con tapón y cadena.

Waste outlet with plug and chain.

Blister: 112 x 167 x 60 mm



S-35

Cod. Barras / Bar Code	Ref.	Medida / Size	Color / Colour	U/
8410787024465	88010036	1 1/4"xØ63 mm	○	10 8,06€
8410787024472	88010048	1 1/2"xØ63 mm	○	10 8,15€

Válvula con tapón y cadena.

Waste outlet with PVC plug and chain.

Blister: 112 x 167 x 60 mm



S-382

Cod. Barras / Bar Code	Ref.	Medida / Size	Color / Colour	U/
8410787028265	88011316	1 1/4"xØ32/40 mm	○	4 11,20€
8410787028272	88011318	1 1/2"xØ40/50 mm	○	4 11,83€

Válvula de Ø 70 con tubo flexible (para conexiones de difícil acceso. No utilizar como sifón de desagüe).

Waste outlet with flexible connector. (For difficult to reach connections. Not to be used as a trap).

Blister: 158 x 245 x 71 mm

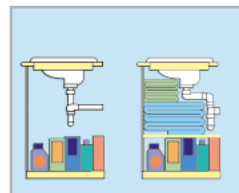

S-305

Cod. Barras / Bar Code	Ref.	Medida / Size	Color / Colour	U/ 
------------------------	------	---------------	----------------	--

8410787024458	88006978	1 1/2"xØ40 mm	○	4 18,42€
---------------	-----------------	---------------	---	-----------------

Sifón curvo desplazado - Ahorra espacio.
Curved trap - Special for space saving.

 Blister: 250 x 340 x 80 mm

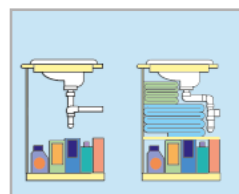

S-304

Cod. Barras / Bar Code	Ref.	Medida / Size	Color / Colour	U/ 
------------------------	------	---------------	----------------	--

8410787027800	88006968	1 1/2"xØ40 mm	○	4 20,22€
---------------	-----------------	---------------	---	-----------------

Sifón curvo desplazado con toma de electrodoméstico. Ahorra espacio.

Space saving "S" trap. Horizontal outlet with appliance inlet connector.

 Blister: 250 x 340 x 80 mm



S-50

Cod. Barras / Bar Code	Ref.	Medida / Size	Color / Colour	U/ 
------------------------	------	---------------	----------------	--

8410787027794	88005108	1 1/2"xØ40 mm	○	4 21,75€
---------------	-----------------	---------------	---	-----------------

Colector sífónico curvo, extensible para fregaderos dobles. Con toma de electrodoméstico.

Central collector with S-trap, adjustable, horizontal outlet, threaded, with appliance inlet.

 Blister: 250 x 340 x 80 mm

Fregadero / Sink



S-319

Cod. Barras / Bar Code	Ref.	Medida / Size	Color / Colour	U	U
8410787024427	88005508	1 1/2"xØ40 mm	○	6	15,71€

Colector extensible para fregaderos dobles.
Extra flat collector with fittings.

Blister: 185 x 295 x 55 mm



S-31

Cod. Barras / Bar Code	Ref.	Medida / Size	Color / Colour	U	U
8410787024434	88006028	1 1/2"xØ40 mm	○	8	9,79€

Sifón curvo con cuello extensible.
Curved trap with extendable neck.

Blister: 163 X 252 X 69 mm



S-67

Cod. Barras / Bar Code	Ref.	Medida / Size	Color / Colour	U	U
8410787027947	88006088	1 1/2"xØ40 mm	○	4	10,33€

Sifón curvo extensible con salida orientable.
Adjustable "S" trap, inclined outlet, threaded.

Blister: 158 x 245 x 71 mm



S-51

Cod. Barras / Bar Code	Ref.	Medida / Size	Color / Colour	U	U
8410787028005	88014038	1 1/2"xØ115 mm	○	4	17,36€

Válvula de desagüe con rebosadero rectangular.
Flexible rectangular overflow with plug, for kitchen sinks.

Blister: 158 x 245 x 71 mm



S-230

Cod. Barras / Bar Code	Ref.	Medida / Size	Color / Colour	U	U
8410787028012	88014069	1 1/4"xØ115 mm	○	8	31,03€

Válvula de cesta de altura reducida - Con rebosadero redondo o cuadrado.

Basket waste outlet with flexible, with round or rectangular overflow drain.

Blister: 127 x 268 x 104 mm

Fregadero / Sink



S-435

Cod. Barras / Bar Code	Ref.	Medida / Size	Color / Colour	U/ 
8410787027824	88011538	1 1/2"xØ115 mm	○	8 22,55€

Válvula de desagüe vertical de altura reducida con cestillo.
Basket waste outlet for kitchen sinks made of stainless steel.

 Blister: 185 x 295 x 55 mm



S-158

Cod. Barras / Bar Code	Ref.	Medida / Size	Color / Colour	U/ 
8410787024489	88011058	1 1/2"xØ70 mm	○	10 8,08€

Válvula de desagüe con tapón de PVC.
Waste outlet with PVC plug.

 Blister: 112 x 167 x 60 mm

Plato de ducha / Shower tray



S-128

Cod. Barras / Bar Code	Ref.	Medida / Size	Color / Colour	U/	
8410787027978	88012050	Ø40 x Ø80 mm	○	10	8,38€

Válvula de desagüe vertical, salida PVC encolar.
Shower tray vertical PVC outlet (to glue).

Blister: 135 x 212 x 90 mm



S-134

Cod. Barras / Bar Code	Ref.	Medida / Size	Color / Colour	U/	
8410787024502	88012068	1 1/2"xØ80 mm	○	8	9,24€
8410787027985	88012108	1 1/2"xØ115 mm	○	8	11,68€

Válvula de desagüe sifónica.
Trap siphonic horizontal outlet.

Blister: 135 x 212 x 90 mm



S-28

Cod. Barras / Bar Code	Ref.	Medida / Size	Color / Colour	U/	
8410787027831	88012038	1 1/2"xØ70 mm	○	8	7,96€
8410787024519	88012148	1 1/2"xØ80 mm	○	8	7,96€

Válvula con salida horizontal no sifónica.
Trap horizontal outlet.

Blister: 135 x 212 x 90 mm



S-578

Cod. Barras / Bar Code	Ref.	Medida / Size	Color / Colour	U/	
8410787034983	88012279	1 1/2"xØ115 mm	○	6	32,82€

Válvula para plato de ducha con orificio de salida Ø 115 mm. Salida con junta para tubos lisos Ø 40 mm.
Outlet with joint for non-adhesive smooth pipes, Ø115 For shower trays with Ø 40 outlet.

Blister: 135 x 212 x 90 mm



S-373

Cod. Barras / Bar Code	Ref.	Medida / Size	Color / Colour	U/	
8410787024526	88012198	1 1/2" x Ø85 mm	○	6	25,83€

Válvula para plato de ducha con orificio de salida Ø 60 mm. Salida con junta para tubos lisos Ø 40 mm.
Outlet with joint for non-adhesive smooth pipes, Ø 40. For shower trays with Ø 60 outlet.

Blister: 127 x 268 x 104 mm



S-374

Cod. Barras / Bar Code	Ref.	Medida / Size	Color / Colour	U/	
8410787027992	88012518	1 1/2"xØ115 mm	○	6	62,09€
8410787028128	88012308	1 1/2"xØ70 mm	○	6	40,21€

Válvula para plato de ducha con orificio de salida Ø 90 mm o Ø 50 mm. Salida con junta para tubos lisos Ø 40 mm.
Outlet with joint for non-adhesive smooth pipes, Ø 90 or Ø 50. For shower trays with Ø 40 outlet.

Blister: 135 x 212 x 90 mm



A-137

Cod. Barras / Bar Code	Ref.	Medida / Size	Color / Colour	U/ 
8410787024724	88022250	1 1/4" x Ø32 mm	○	6 9,11€

Enlace acodado para tubos lisos.
Female bend for smooth tubes.

 Blister: 89 x 157 x 40 mm



A-72

Cod. Barras / Bar Code	Ref.	Medida / Size	Color / Colour	U/ 
8410787024557	88022029	1 1/4" x Ø32 mm	○	6 7,70€

Enlace acodado macho/hembra.
Bend male/female.

 Blister: 89 x 157 x 40 mm



A-79

Cod. Barras / Bar Code	Ref.	Medida / Size	Color / Colour	U/ 
8410787027879	88022036	1 1/2" x Ø40 mm	○	8 5,80€

Codo rosca una boca.
Threaded bend one mouth.

 Blister: 89 x 157 x 40 mm



A-7

Cod. Barras / Bar Code	Ref.	Medida / Size	Color / Colour	U/ 
8410787024625	88022078	1 1/2" x Ø40 mm	○	8 5,47€

Codo rosca una boca hembra para tubos lisos.
Female bend for smooth tubes

 Blister: 89 x 157 x 40 mm



A-8

Cod. Barras / Bar Code	Ref.	Medida / Size	Color / Colour	U/ 
8410787024632	88022088	1 1/2" x Ø40 mm	○	8 5,80€

Codo hembra para tubos lisos.
Female bend for smooth tubes.

 Blister: 114 x 191 x 70 mm



A-112

Cod. Barras / Bar Code	Ref.	Medida / Size	Color / Colour	U/ 
8410787024595	88022052	1 1/4" x Ø32 mm	○	10 10,83€
8410787024601	88022053	1 1/2" x Ø40 mm	○	10 10,85€

Válvula de aireación intercambiable.
Anti-vac valve.

 Blister: 112 x 169 x 35 mm



A-4

Cod. Barras / Bar Code	Ref.	Medida / Size	Color / Colour	U	U
8410787027893	88022140	1 1/4" x Ø32 mm	○	10	6,49€
8410787027909	88022150	1 1/4" x Ø40 mm	○	10	6,66€

Acoplamiento a pared con embellecedor - 180 mm.
Wall coupling with bulkhead - 180 mm.

Blister: 120 x 290 x 70 mm



A-35

Cod. Barras / Bar Code	Ref.	Medida / Size	Color / Colour	U	U
8410787024823	88022800	1 1/4" x Ø32 mm	○	10	13,72€

Acoplamiento a pared con embellecedor - 180 mm.
Wall coupling with bulkhead - 180 mm.

Blister: 120 x 290 x 70 mm



A-68

Cod. Barras / Bar Code	Ref.	Medida / Size	Color / Colour	U	U
8410787024540	88022021	Ø32 mm	○	10	6,87€

Plafón embellecedor para tubos lisos.
Bulkhead for smooth extensions.

Blister: 112 x 169 x 35 mm



S-123

Cod. Barras / Bar Code	Ref.	Medida / Size	Color / Colour	U	U
8410787028098	88031302	Ø32 mm	○	10	9,61€
8410787028104	88031303	Ø40 mm	○	10	9,76€

Plafón embellecedor oval para tubos lisos.
Oval chrome finished bulk head fitting.

Blister: 112 x 169 x 35 mm



A-15

Cod. Barras / Bar Code	Ref.	Medida / Size	Color / Colour	U	U
8410787024731	88022316	1 1/4 x Ø32 mm	○	10	6,71€
8410787024748	88022348	1 1/2 x Ø40 mm	○	10	7,23€

Alargadera macho/hembra - 180 mm.
One mount extension for smooth tubes - 180 mm.

Blister: 120 x 290 x 70 mm



A-44

Cod. Barras / Bar Code	Ref.	Medida / Size	Color / Colour	U	U
8410787028074	88030003	Ø32 x 125 mm	○	10	8,24€

Alargadera de latón - 125 mm.
Brass extension / 125 mm.

Blister: 112 x 169 x 35 mm



A-13

Cod. Barras / Bar Code	Ref.	Medida / Size	Color / Colour	U/	
8410787027886	88022138	1 1/2"	○	10	6,49€

Alargadera dos bocas para tubos lisos - 174 mm.
Two mouths extension for smooth tubes - 174 mm

Blister: 120 x 290 x 70 mm



A-2

Cod. Barras / Bar Code	Ref.	Medida / Size	Color / Colour	U/	
8410787027916	88022200	1 1/4"xØ32 mm	○	6	3,78€
8410787028036	88022210	1 1/2"xØ40 mm	○	10	4,66€

Racor con valona y tuerca loca.
Threaded inlet with stop end and sliding nut.

Blister: 112 x 169 x 35 mm



S-273

Cod. Barras / Bar Code	Ref.	Medida / Size	Color / Colour	U/	
8410787027848	88017110	Ø59 - INT Ø12	○	6	8,28€
8410787027855	88017120	Ø59 - INT Ø16	○	6	7,90€

10 plafones partidos para tubo.
10 divided covers for tube.

Blister: 114 x 191 x 70 mm



A-104

Cod. Barras / Bar Code	Ref.	Medida / Size	Color / Colour	U/	
8410787024571	88022044	1 1/4" - 32/40 mm	○	6	9,32€
8410787024588	88022045	1 1/4" - 32/50 mm	○	6	9,95€

Manguito flexible con junta cónica.
Flexible sleeve with flat joint.

Blister: 185 x 295 x 55 mm



A-14

Cod. Barras / Bar Code	Ref.	Medida / Size	Color / Colour	U/	
8410787024717	88022248	Ø40 x Ø40 mm	○	6	4,34€
8410787024694	88022236	Ø32 x Ø32 mm	○	6	3,97€

Enlace hembra para unión de tubos lisos.
Female fitting for smooth tubes.

Blister: 89 x 157 x 40 mm



A-3

Cod. Barras / Bar Code	Ref.	Medida / Size	Color / Colour	U/	
8410787024649	88022160	1 1/4" x Ø32 mm	●	6	3,91€
8410787024656	88022170	1 1/2" x Ø40 mm	●	6	3,91€

Enlace mixto macho.
Mixed male link.

Blister: 89 x 157 x 40 mm



A-12

Cod. Barras / Bar Code	Ref.	Medida / Size	Color / Colour	U/	
8410787024670	88022195	1 1/4" x Ø40 mm	●	6	4,34€
8410787028067	88022260	1 1/2" x Ø40 mm	●	10	4,34€

Enlace mixto hembra.

Mixed female link.

Blister: 89 x 157 x 40 mm



A-37

Cod. Barras / Bar Code	Ref.	Medida / Size	Color / Colour	U/	
8410787028043	88022216	1 1/2" x Ø40 mm	●	10	6,49€

Enlace mixto acodado para instalación de tubos de PVC con accesorios roscados no encolables.

Solvent socket female elbow union.

Blister: 89 x 157 x 40 mm



A-11

Cod. Barras / Bar Code	Ref.	Medida / Size	Color / Colour	U/	
8410787028050	88022258	1 1/2"	○	10	6,00€

Racor toma desagüe electrodomésticos con valona y tuerca loca. Para tubos lisos.

Raiser with loose nut-sanit appl. inlet.

Blister: 89 x 157 x 40 mm



A-1

Cod. Barras / Bar Code	Ref.	Medida / Size	Color / Colour	U/	
8410787024687	88022228	1 1/2" x Ø40 mm	○	8	6,16€

Racor con toma electrodoméstico.

Extendible neck with one inlet fitting.

Blister: 114 x 191 x 70 mm



A-50

Cod. Barras / Bar Code	Ref.	Medida / Size	Color / Colour	U/	
8410787027862	88022000	1 1/2" x Ø40 mm	○	8	7,10€

Cuello extensible con doble toma electrodomésticos.

Fitting for two wash machine connections.

Blister: 89 x 157 x 40 mm



A-49

Cod. Barras / Bar Code	Ref.	Medida / Size	Color / Colour	U/	
8410787024700	88022242	Ø40 mm	○	6	4,60€

Enlace mixto con toma electrodoméstico.

Glue-on PVC male fitting.

Blister: 89 x 157 x 40 mm

Accesorios / Accessories



A-55

Cod. Barras / Bar Code	Ref.	Medida / Size	Color / Colour	U/	
8410787028029	88022006	1 1/2" x Ø40 mm	●	10	5,71€

Codo toma electrodomésticos para encolar.
Appliance intake elbow solvent socket.

Blister: 89 x 157 x 40 mm



A-122

Cod. Barras / Bar Code	Ref.	Medida / Size	Color / Colour	U/	
8410787024618	88022070	Ø40 mm	●	8	6,16€

Enlace macho con doble toma electrodoméstico.
Double Glue-on PVC male fitting.

Blister: 114 x 191 x 70 mm



Cod. Barras / Bar Code	Ref.	Medida / Size	Color / Colour	U/	
8410787024755	88022400	270 mm	○	10	4,56€

Cadena de bolas con espiquilla y anilla.
Ball chain with rings and pin.

Blister: 118 x 135 x 21 mm



Cod. Barras / Bar Code	Ref.	Medida / Size	Color / Colour	U/	
8410787024762	88022410	270 mm	○	10	3,97€
8410787024786	88022490	380 mm	○	10	4,22€

Cadena de bolas con anillas.
Ball chain with rings.

Blister: 118 x 135 x 21 mm



A-61

Cod. Barras / Bar Code	Ref.	Medida / Size	Color / Colour	U/	
8410787024533	88022018	Ø70 - 400 mm	○	10	15,06€

Tapón con junta y anilla - Fabricado en latón.
Plug with joint and ring - Made of brass.

Blister: 118 x 135 x 21 mm



A-30

Cod. Barras / Bar Code	Ref.	Medida / Size	Color / Colour	U/	
8410787024793	88022550	Ø70 - 380 mm	○	10	42,45€

Conjunto bañera con embellecedor y tapón de Ø 45 mm.
Set of brass grid, plug and chain and grid.

Blister: 118 x 135 x 21 mm



A-46

Cod. Barras / Bar Code	Ref.	Medida / Size	Color / Colour	U/	
8410787024953	88031179	Ø45 / 270 mm	●	10	5,83€
8410787024960	88031180	Ø45 / 380 mm	●	10	6,02€
8410787024984	88031204	Ø38 / 270 mm	●	10	5,71€

Tapón con cadena.
Plug with chain.

Blister: 118 x 135 x 21 mm



A-31

Cod. Barras / Bar Code	Ref.	Medida / Size	Color / Colour	U/	
8410787024809	88022600	Ø70 / 250 mm	○	10	24,63€

Conjunto tapón de Ø 45 mm con rejilla y cadena.
Set of brass grid, plug and chain.

Blister: 118 x 135 x 21 mm



A-32

Cod. Barras / Bar Code	Ref.	Medida / Size	Color / Colour	U/	
8410787024816	88022650	Ø70 / 250 mm	○	10	33,65€

Conjunto tapón rejilla con cadena, embellecedor y espiguilla.
Set of brass grid with plug, chain and pin.

Blister: 118 x 135 x 21 mm



A-46

Cod. Barras / Bar Code	Ref.	Medida / Size	Color / Colour	U/	
8410787024885	88031012	Ø45 mm	●	10	3,75€
8410787024977	88031203	Ø38 mm	●	10	3,38€

Tapón con anilla.
Plug with ring.

Blister: 118 x 135 x 21 mm



Cod. Barras / Bar Code	Ref.	Medida / Size	Color / Colour	U/	
8410787028081	88031289	Ø115 mm	○	10	6,97€

Tapón rejilla completa para válvula de cesta de altura reducida.
Grid plug for basket waste outlet.

Blister: 112 x 169 x 35 mm



Cod. Barras / Bar Code	Ref.	Medida / Size	Color / Colour	U/	
8410787024946	88031166	Ø55 mm	○	15	7,03€

Tapón rejilla completa para válvula de cesta.
Grid plug for basket waste outlet.

Blister: 112 x 169 x 35 mm



A-75

Cod. Barras / Bar Code	Ref.	Medida / Size	Color / Colour	U/
8410787024564	88022034	Ø45 mm	●	10 3,75€

Tapón para válvula desagüe de fregadero.

Plug with handle for sink outlets.

Blister: 118 x 135 x 21 mm



A-26

Cod. Barras / Bar Code	Ref.	Medida / Size	Color / Colour	U/
8410787024779	88022430	Ø40 x Ø32 mm	●	10 3,48

Junta reductora para tubos lisos.

Reducing joint for smooth tube mouths.

Blister: 118 x 135 x 21 mm



Cod. Barras / Bar Code	Ref.	Medida / Size	Color / Colour	U/
8410787024892	88031015	1 1/2" x Ø40 mm	●	10 5,37€

4 juntas cónicas flexibles. 4 conical flexible joints.

Blister: 118 x 135 x 21 mm



Cod. Barras / Bar Code	Ref.	Medida / Size	Color / Colour	U/
8410787024908	88031027	1 1/2" x Ø40 mm	●	10 5,37€

4 juntas planas para racor de 1 1/2". 4 joints for 1 1/2" outlet.

Blister: 118 x 135 x 21 mm



S-130

Cod. Barras / Bar Code	Ref.	Medida / Size	Color / Colour	U/
8410787027923	88026010	Ø90xØ115 mm	○	8 11,16€
8410787024878	88026000	Ø110xØ145 mm	○	8 11,92€

Tapa para bote expansión en acero inoxidable.

Expansion lid with stainless steel trimming.

Blister: 173 x 195 x 39 mm



Cod. Barras / Bar Code	Ref.	Medida / Size	Color / Colour	U/
8410787024922	88031111	Ø145 mm	○	8 8,55€

Chapa para tapa bote sifónico.

Trimming for expansion lid.

Blister: 173 x 195 x 39 mm



Cod. Barras / Bar Code	Ref.	Medida / Size	Color / Colour	U/
8410787024991	88031206	Ø63 mm	○	10 5,37€
8410787024915	88031030	Ø70 mm	○	10 5,37€
8410787024939	88031162	Ø85 mm	○	10 5,37€

4 juntas planas para válvula de fregadero.

4 flat joints for sink valve.

Blister: 118 x 135 x 21 mm

Ahorra Agua
Saves Water



Fácil Instalación
Easy to Install



Mecanismo universal 3g - 3g *Universal mechanism*

Mecanismo de descarga universal. Un sólo modelo permite la instalación en inodoros provistos con base roscada (ej. modelos Roca anteriores a 2007) o con enchufe rápido (modelos posteriores a 2007).

Universal Double volume mechanism. Easy and fast installation (adaptable to the "Roca" base).



S-585

Cod. Barras / Bar Code	Ref.	Medida / Size	Color / Colour	U/
8410787034907	88023387	-	○	2 44,39€

Incluye tornillos de fijación de tanque bajo al WC y junta de recambio.
Includes cistern Kit connector with screw.

Blister: 238 x 339 x 55 mm



Cod. Barras / Bar Code	Ref.	Medida / Size	Color / Colour	U/
8410787034976	88023308A	-	○	12 32,63€

Bolsa con solapa - Bag with hanger: 205 x 380 x 55 mm



Grifo Dual - *Compact float valve*

Grifo flotador DUAL adaptable a cualquier cisterna. Permite el uso de entrada lateral o inferior con rosca de 3/8" en latón y filtro de toma. Con una toma de 3/8" de latón que puede roscarse en la entrada lateral o en inferior del grifo flotador, provista de filtro de toma. Regulable en altura. Presión de trabajo de 0,5 a 16 bar.

Compact float valve, horizontal or vertical inlet 3/8" threaded brass and Filter outlet included. Height adjustable. 0.5 to 16 bar working press



S-465

Cod. Barras / Bar Code	Ref.	Medida / Size	Color / Colour	U/
8410787034952	88023250	3/8"	○	6 26,90€

Blister: 185 x 295 x 55 mm



Cod. Barras / Bar Code	Ref.	Medida / Size	Color / Colour	U/
8410787034969	88023250A	3/8"	○	18 17,27€

Bolsa con solapa - Bag with hanger: 205 x 380 x 55 mm



Interbath bolsa / *Interbath in bag*

Mangos de ducha / <i>Handshowers</i>	110
Conjuntos para WC / <i>WC shower sets</i>	117
Difusores / <i>Shower heads</i>	118
Barras murales / <i>Slide bars</i>	119
Flexibles / <i>Shower hoses</i>	120
Soportes para mango / <i>Handshower supports</i>	121
Accesorios / <i>Accessories</i>	122

Mangos de ducha / Handshowers

MASAJE 6 FUNCIONES / MASSAGE 6 FUNCTIONS

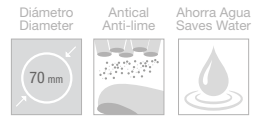
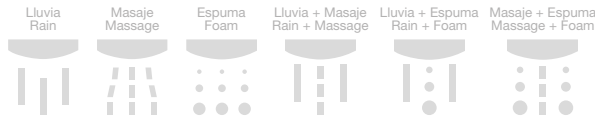

Mango - Handshower

Cod. Barras / Bar Code	Ref.	Color / Colour	U/ 
8410787026339	50081202	○	20 8,26€
8410787026346	50081214	○	20 11,61€

Mango de 6 funciones - Anticalcáreo - Ahorra agua.
6 jets handshower - Anti-lime system - Saves water.

 Bolsa - Bag: 125 x 300 x 70 mm



Combi

Cod. Barras / Bar Code	Ref.	Color / Colour	U/ 
8410787026285	50041202	○	8 17,16€
8410787026292	50041214	○	8 23,52€

Mango de 6 funciones - Flexible plástico de 1,5 m - Soporte - Kit de tacos y tornillos.

6 jets handshower - 1,5 m plastic shower hose - Support - Kit of screws and plugs.

 Bolsa - Bag: 220 x 300 x 70 mm



Variant

Cod. Barras / Bar Code	Ref.	Color / Colour	U/ 
8410787026391	50031202	○	4 27,01€
8410787026407	50031214	○	4 31,96€

Mango de 6 funciones - Flexible plástico de 1,5 m - Barra mural 60 cm Ø 20 mm - Kit de tacos y tornillos.

6 jets handshower - 1,5 m plastic shower hose - Slide bar 60 cm Ø 20 mm - Kit of screws and plugs.

 Bolsa - Bag: 180 x 710 x 70 mm

Mangos de ducha / Handshowers

MASAJE 3 FUNCIONES / MASSAGE 3 FUNCTIONS

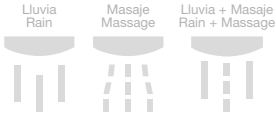

Mango - Handshower

Cod. Barras / Bar Code	Ref.	Color / Colour	U/ 
8410787026353	50081702	○	20 5,61€
8410787026377	50081731	●	20 5,61€
8410787026360	50081714	○	20 7,39€

Mango de 3 funciones - Ahorra agua.
3 jets handshower - Saves water.

 Bolsa - Bag: 125 x 300 x 50 mm



Combi

Cod. Barras / Bar Code	Ref.	Color / Colour	U/ 
8410787026308	50041702	○	8 11,90€
8410787026322	50041731	●	8 11,90€
8410787026315	50041714	○	8 15,55€

Mango de 3 funciones - Flexible plástico de 1,5 m - Soporte - Kit de tacos y tornillos.

3 jets handshower - 1,5 m plastic shower hose - Support - Kit of screws and plugs.

 Bolsa - Bag: 220 x 300 x 50 mm



Variant

Cod. Barras / Bar Code	Ref.	Color / Colour	U/ 
8410787026261	50031702	○	4 16,59€
8410787026278	50031714	○	4 23,10€

Mango de 3 funciones - Flexible plástico de 1,5 m - Barra mural 60 cm Ø 20 mm - Kit de tacos y tornillos.

3 jets handshower - 1,5 m plastic shower hose - Slide bar 60 cm Ø 20 mm - Kit of screws and plugs.

 Bolsa - Bag: 180 x 710 x 50 mm

Mangos de ducha / Handshowers

ANTICAL 1 FUNCIÓN / ANTI-LIME 1 FUNCTION

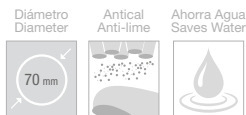

Mango - Handshower

Cod. Barras / Bar Code	Ref.	Color / Colour	U/ 
8410787026674	50081302	○	20 4,69€
8410787026681	50081314	○	20 6,33€

Mango de 1 función - Anticalcáreo - Ahorra agua.
1 jet handshower - Anti-lime system - Saves water.

 Bolsa - Bag: 125 x 300 x 70 mm



Combi

Cod. Barras / Bar Code	Ref.	Color / Colour	U/ 
8410787026476	50041302	○	8 9,15€
8410787026483	50041314	○	8 11,96€

Mango de 1 función - Flexible plástico de 1,5 m - Soporte - Kit de tacos y tornillos.

1 jet handshower - 1,5 m plastic shower hose - Support - Kit of screws and plugs.

 Bolsa - Bag: 220 x 300 x 70 mm



Variant

Cod. Barras / Bar Code	Ref.	Color / Colour	U/ 
8410787026414	50031302	○	4 15,17€
8410787026421	50031314	○	4 21,23€

Mango de 1 función - Flexible plástico de 1,5 m - Barra mural 60 cm Ø 20 mm - Kit de tacos y tornillos.

1 jet handshower - 1,5 m plastic shower hose - Slide bar 60 cm Ø 20 mm - Kit of screws and plugs.

 Bolsa - Bag: 180 x 710 x 70 mm

Mangos de ducha / Handshowers

ANTICAL BÁSICO 1 FUNCIONES / ANTI-LIME STANDARD 1 FUNCTIONS

Lluvia + Masaje
Rain + Massage



Diámetro
Diameter



Antical
Anti-lime



Ahorra Agua
Saves Water



Mango - Handshower

Cod. Barras / Bar Code	Ref.	Color / Colour	U/ 	
8410787026735	50081802	○	20	2,89€
8410787026759	50081831	●	20	2,81€
8410787026742	50081814	○	20	4,87€

Mango de 1 función - Anticalcáreo - Ahorra agua.

1 jet handshower - Anti-lime system - Saves water.

 Bolsa - Bag: 125 x 300 x 50 mm



Combi

Cod. Barras / Bar Code	Ref.	Color / Colour	U/ 	
8410787026537	50041802	○	8	7,71€
8410787026551	50041831	●	8	7,99€
8410787026544	50041814	○	8	9,97€

Mango de 1 función - Flexible plástico de 1,5 m - Soporte - Kit de tacos y tornillos.

1 jet handshower - 1,5 m plastic shower hose - Support - Kit of screws and plugs.

 Bolsa - Bag: 220 x 300 x 50 mm

Mangos de ducha / Handshowers

LLUVIA 1 FUNCIÓN / RAIN 1 FUNCTION



Mango - Handshower

Cod. Barras / Bar Code	Ref.	Color / Colour	U/ 
8410787026704	50081402	○	20 3,56€
8410787026698	50081414	○	20 5,93€

Mango de 1 función - Ahorra agua.
1 jet handshower - Saves water.

 Bolsa - Bag: 125 x 300 x 70 mm



Combi

Cod. Barras / Bar Code	Ref.	Color / Colour	U/ 
8410787026490	50041402	○	8 7,60€
8410787026506	50041414	○	8 10,66€

Mango de 1 función - Flexible plástico de 1,5 m - Soporte - Kit de tacos y tornillos.

1 jet handshower - 1,5 m plastic shower hose - Support - Kit of screws and plugs.

 Bolsa - Bag: 220 x 300 x 70 mm



Variant

Cod. Barras / Bar Code	Ref.	Color / Colour	U/ 
8410787026438	50031402	○	4 14,61€
8410787026445	50031414	○	4 20,18€

Mango de 1 función - Flexible plástico de 1,5 m - Barra mural 60 cm Ø 20 mm - Kit de tacos y tornillos.

1 jet handshower - 1,5 m plastic shower hose - Slide bar 60 cm Ø 20 mm - Kit of screws and plugs.

 Bolsa - Bag: 180 x 710 x 70 mm



Mango - Handshower

Cod. Barras / Bar Code	Ref.	Color / Colour	U/ 
8410787026766	50081902	○	20 <i>2,43€</i>
8410787026780	50081931	●	20 <i>2,45€</i>
8410787026773	50081914	○	20 <i>4,43€</i>

Mango de 1 función - Ahorra agua.
1 jet handshower - Saves water.

 Bolsa - Bag: 125 x 300 x 50 mm



Combi

Cod. Barras / Bar Code	Ref.	Color / Colour	U/ 
8410787026575	50041902	○	8 <i>7,00€</i>
8410787026568	50041901	●	8 <i>7,51€</i>
8410787026582	50041914	○	8 <i>9,48€</i>

Mango de 1 función - Flexible plástico de 1,5 m - Soporte - Kit de tacos y tornillos.

1 jet handshower - 1,5 m plastic shower hose - Support - Kit of screws and plugs.

 Bolsa - Bag: 220 x 300 x 50 mm



Variant

Cod. Barras / Bar Code	Ref.	Color / Colour	U/ 
8410787026452	50031902	○	4 <i>13,03€</i>
8410787026469	50031914	○	4 <i>18,36€</i>

Mango de 1 función - Flexible plástico de 1,5 m - Barra mural 60 cm Ø 20 mm - Kit de tacos y tornillos.

1 jet handshower - 1,5 m plastic shower hose - Slide bar 60 cm Ø 20 mm - Kit of screws and plugs.

 Bolsa - Bag: 180 x 710 x 50 mm

Mangos de ducha / Handshowers

MINIMALISTA / MINIMALIST



Mango - Handshower

Cod. Barras / Bar Code	Ref.	Color / Colour	U/
8410787026711	50081514	○	20 10,48€

Mango de ducha minimalista tubular - Función lluvia con membrana anticalcárea - Fabricado en ABS cromado - Longitud: 22 cm.

Tubular minimalist handshower - Rain function with anti-lime membrane - Made in chromed ABS - Lenght 22 cm.

Bolsa - Bag: 125 x 300 x 30 mm



Combi

Cod. Barras / Bar Code	Ref.	Color / Colour	U/
8410787026513	50041514	○	8 19,27€

Mango de 1 función - Anticalcáreo - Soporte Superform - Flexible metálico extensible hasta 2 m - Kit de tacos y tornillos.

1 jet handshower - Anti-lime system - Superform handshower support - Metallic shower hose extensible up to 2 m - Kit of screws and plugs.

Bolsa - Bag: 220 x 300 x 40 mm



Mango - Handshower

Cod. Barras / Bar Code	Ref.	Color / Colour	U/
8410787026728	50081614	○	20 10,48€

Mango de ducha minimalista de líneas cuadradas - Función lluvia con membrana anticalcárea - Fabricado en ABS cromado - Longitud: 23 cm.

Square minimalist handshower - Rain function with anti-lime membrane - Made in chromed ABS - Lenght 23 cm.

Bolsa - Bag: 125 x 300 x 30 mm



Combi

Cod. Barras / Bar Code	Ref.	Color / Colour	U/
8410787026520	50041614	○	8 19,27€

Mango de 1 función - Anticalcáreo - Soporte Superform - Flexible metálico extensible hasta 2 m - Kit de tacos y tornillos.

1 jet handshower - Anti-lime system - Superform handshower support - Metallic shower hose extensible up to 2 m - Kit of screws and plugs.

Bolsa - Bag: 220 x 300 x 40 mm



Conjuntos de ducha higiénicos con y sin válvula ideales para la sustitución del bidé.

Mango de ducha higiénico. Función lluvia con botón de parada. Fabricado en ABS cromado. Diámetro del difusor: 3 cm. Longitud: 19 cm. Soporte de pared en ABS cromado. Flexible de metal de 1,20 m.

Shower sets with and without valve for replacing the bidet.

Hygienic shower handle. Rain Function with stop button. Made of chromed ABS. Diffuser Diameter: 3 cm. Length: 19 cm. Handshower support made of chromed ABS. Metallic 1,20m shower hose.



Conjunto para WC - WC shower set

Cod. Barras / Bar Code	Ref.	Color / Colour	U/
8410787033856	50050014		8 14,81€

Mango de 1 función con botón ON/OFF - Soporte a pared - Flexible metálico de 1,20 m - Incluye taco y tonillo para su instalación.

1 function handshower with ON/OFF button - Shower holder - Metallic 1,20 m. shower hose - Kit of screw and plug.

Bolsa - Bag: 240 x 300 x 50 mm



Conjunto con válvula para WC - WC set with valve

Cod. Barras / Bar Code	Ref.	Color / Colour	U/
8410787033863	50060014		8 19,83€

Mango de 1 función con botón ON/OFF - Soporte a pared - Flexible metálico de 1,20 m - Válvula de latón de 1/2"x1/2" - Incluye taco y tonillo para su instalación.

1 function handshower with ON/OFF button - Shower holder - Metallic 1,20 m. shower hose - Brass 1/2" x 1/2" valve - Kit of screw and plug.

Bolsa - Bag: 240 x 300 x 50 mm



Válvula inversora fabricada en latón para adaptar el conjunto de wc a una toma de alimentación de cisterna existente. **Dos salidas independientes para un misma toma.**

Valve made in brass to adapt the wc set to standard existing cistern. **Two independent outlet for a single inlet.**



Válvula 3 vías para WC 3 ways valve for WC

Cod. Barras / Bar Code	Ref.	Color / Colour	U/
8410787034402	22040414		6 26,48€

Válvula de 3 vías en latón - Medida: 1/2"x1/2"x1/2".

Brass three ways valve - Size 1/2"x1/2"x1/2".

Caja - Bag: 120 x 90 x 65



Conjuntos para WC / WC Shower sets

FUNCIÓN STOP / STOP HANDSHOWER



Stop
Diámetro
Diameter
45 mm



Stop
Diámetro
Diameter
45 mm

Mango - Handshower

Cod. Barras / Bar Code	Ref.	Color / Colour	U/	
8410787027190	50081102	○	20	4,78€
8410787026667	50081114	○	20	5,78€

Mango de 1 función - Función stop - Ahorra agua.
1 jet handshower - Stop jet - Saves water.

Bolsa - Bag: 125 x 300 x 30 mm

Combi

Cod. Barras / Bar Code	Ref.	Color / Colour	U/	
8410787027183	50031102	○	8	12,67€
8410787026384	50031114	○	8	15,37€

Mango de 1 función - Flexible metálico de 1,5 m - Soporte fijo - Kit de tacos y tornillos.

1 jet handshower - 1,5 m metallic shower hose - Fixed handshower support - Kit of screws and plugs.

Bolsa - Bag: 220 x 300 x 40 mm

DIFUSORES 1 FUNCIÓN / SHOWER HEADS 1 FUNCTION



Lluvia
Rain
70 mm



Lluvia
Rain
50 mm



Antical - Anti-lime

Cod. Barras / Bar Code	Ref.	Color / Colour	U/	
8410787027022	50170702	○	6	6,14€
8410787027039	50170714	○	6	7,25€

Difusor de ducha anticalcáreo de 1 función
1 function anti-lime shower head.

Bolsa - Bag: 125 x 143 x 70 mm



Lluvia básica - Standard rain

Cod. Barras / Bar Code	Ref.	Color / Colour	U/	
8410787027046	50170802	○	6	2,11€

Difusor de ducha de 1 función
1 function shower head.

Bolsa - Bag: 125 x 143 x 50 mm



Brazo de ducha - Shower arm

Cod. Barras / Bar Code	Ref.	Color / Colour	U/	
8410787027053	50170914	○	15	5,78€

Brazo de ducha a pared con embellecedor - Fabricado en ABS cromado - Difusor no incluido.

Straight shower arm with flange - Made in chromed ABS - Shower arm not included.

Bolsa - Bag: 125 x 143 x 30 mm

Barras murales / Slide bars



Barra mural 75 cm - Slide bar 75 cm

Cod. Barras / Bar Code	Ref.	Medida / Size	Color / Colour	U/ 
8410787026957	50170314	75 cm	○	6 15,96€

Barra mural deslizante con el terminal superior pasante - Cursor regulable en altura - Para enlances cónicos - Longitud total: 75 cm. Ø: 20 mm - Kit de tacos y tornillos.

Slide bar for handshower with upper fixing walls - Clamp bracket adjustable in height. - For conical connections - Length: 75 cm Ø: 20 mm - Kit of screws and plugs.

 Bolsa - Bag: 180 x 710 x 50 mm



Barra mural 70 cm - Slide bar 70 cm

Cod. Barras / Bar Code	Ref.	Medida / Size	Color / Colour	U/ 
8410787027015	50170614	70 cm	○	6 21,01€

Barra mural deslizante de tubo cuadrado - Cursor regulable en altura - Para enlances cónicos - Longitud total: 70 cm - Kit de tacos y tornillos.

Square slide bar - Clamp bracket adjustable in height. - For conical connections - Length: 70 cm - Kit of screws and plugs.

 Bolsa - Bag: 180 x 710 x 50 mm



Barra mural 60 cm - Slide bar 60 cm

Cod. Barras / Bar Code	Ref.	Medida / Size	Color / Colour	U/ 
8410787026964	50170402	60 cm	○	6 8,31€
8410787026971	50170414	60 cm	○	6 12,89€

Barra mural para mango de ducha con cursor deslizante regulable en altura - Para enlances cónicos - Longitud: 60 cm. Ø 20 mm - Kit de tacos y tornillos.

Slide bar for handshower with a clamp bracket adjustable in height. - For conical connections. - Length: 60 cm Ø 20 mm - Kit of screws and plugs.

 Bolsa - Bag: 180 x 710 x 50 mm

Flexibles de ducha / Shower hoses

PLÁSTICO / PLASTIC



Plástico 1,5 m - Plastic 1,5 m

Cod. Barras / Bar Code	Ref.	Medida / Size	Color / Colour	U/	U/
8410787026797	50100002	1,5 m	○	10	4,79€
8410787026803	50100014	1,5 m	○	10	4,79€

Flexible plástico - Enlace cónico en un extremo y tuerca moleteada en el otro - Conexiones universales 1/2" x 1/2".

Plastic shower hose - One conical end and one knurled nut - Universal connections 1/2" x 1/2".

Bolsa - Bag: 220 x 300 x 50 mm

Plástico 2 m - Plastic 2 m

Cod. Barras / Bar Code	Ref.	Medida / Size	Color / Colour	U/	U/
8410787026810	50100102	2 m	○	10	5,41€
8410787026827	50100114	2 m	○	10	5,41€

Flexible plástico - Enlace cónico en un extremo y tuerca moleteada en el otro - Conexiones universales 1/2" x 1/2".

Plastic shower hose - One conical end and one knurled nut - Universal connections 1/2" x 1/2".

Bolsa - Bag: 220 x 300 x 50 mm



Plástico 1,5 m - Plastic 1,5 m

Cod. Barras / Bar Code	Ref.	Medida / Size	Color / Colour	U/	U/
8410787026858	50100402	1,5 m	○	10	4,50€
8410787026865	50100431	1,5 m	●	10	4,50€

Flexible plástico liso - Enlace cónico en un extremo y tuerca moleteada en el otro - Conexiones universales 1/2" x 1/2".

Smooth plastic shower hose - One conical end and one knurled nut - Universal connections 1/2" x 1/2".

Bolsa - Bag: 220 x 300 x 50 mm

Plástico 2 m - Plastic 2 m

Cod. Barras / Bar Code	Ref.	Medida / Size	Color / Colour	U/	U/
8410787026872	50100502	2 m	○	10	5,30€
8410787026889	50100531	2 m	●	10	5,30€

Flexible plástico liso // Enlace cónico en un extremo y tuerca moleteada en el otro // Conexiones universales 1/2" x 1/2".

Smooth plastic shower hose - One conical end and one knurled nut - Universal connections 1/2" x 1/2".

Bolsa - Bag: 220 x 300 x 50 mm

METAL / METALLIC



Metal 1,5 m - Metallic 1,5 m

Cod. Barras / Bar Code	Ref.	Medida / Size	Color / Colour	U/
8410787026834	50100214	1,5 m	○	10 8,51€

Flexible metálico - Enlace cónico en un extremo y tuerca moleteada en el otro - Conexiones universales 1/2" x 1/2".

Metallic shower hose - One conical end and one knurled nut - Universal connections 1/2" x 1/2".

Bolsa - Bag: 220 x 300 x 40 mm



Metal 2 m - Metallic 2 m

Cod. Barras / Bar Code	Ref.	Medida / Size	Color / Colour	U/
8410787026841	50100314	2 m	●	10 9,65€

Flexible metálico - Enlace cónico en un extremo y tuerca moleteada en el otro - Conexiones universales 1/2" x 1/2".

Metallic shower hose - One conical end and one knurled nut - Universal connections 1/2" x 1/2".

Bolsa - Bag: 220 x 300 x 40 mm



Extendible - Extensible

Cod. Barras / Bar Code	Ref.	Medida / Size	Color / Colour	U/
8410787026896	50100614	→ 2 m	○	10 6,45€
8410787026131	AF200214	→ 2 m	○	40 5,36€

Flexible de metal reforzado, con medida extensible hasta 2 m. Conexiones universales 1/2" x 1/2".

Reinforced shower hose with extensible size up to 2 m. Universal connections 1/2" x 1/2".

Bolsa - Bag: 220 x 300 x 40 mm

Bolsa - Bag: 180 x 300 x 40 mm

SOPORTES / SUPPORTS



Soporte - Support

Cod. Barras / Bar Code	Ref.	Color / Colour	U/
8410787026988	50170502	○	10 2,77€
8410787027008	50170531	●	10 2,66€
8410787026995	50170514	○	10 4,76€

Soporte para mango de ducha ajustable y articulado - Para enlaces cónicos - Kit de tacos y tornillos.

Handshower support. Adjustable in angle and direction - For conical connections - Kit of screws and plugs.

Bolsa - Bag: 125 x 143 x 40 mm



Soporte - Support

Cod. Barras / Bar Code	Ref.	Color / Colour	U/
8410787026926	50170202	○	15 1,88€
8410787026940	50170231	●	15 1,73€
8410787026933	50170214	○	15 2,64€

Soporte multiajuste para mangos de ducha - Para enlaces cónicos - Kit de tacos y tornillos.

Handshower support - For conical connections - Kit of screws and plugs.

Bolsa - Bag: 125 x 143 x 30 mm

SOPORTES / SUPPORTS



Rótula - Swivel support

Cod. Barras / Bar Code	Ref.	Color / Colour	U/
8410787026902	50170014	○	6 5,49€

Soporte orientable y articulado - Para mangos de ducha con codo - Kit de tacos y tornillos.

Adjustable in angle and direction - For handshowers with adaptor elbow - Kit of screws and plugs.

Bolsa - Bag: 125 x 143 x 70 mm



Codo - Elbow

Cod. Barras / Bar Code	Ref.	Color / Colour	U/
8410787026636	50070502	○	20 1,38€
8410787026650	50070531	●	20 1,38€
8410787026643	50070514	○	20 1,62€

Conexión para mangos de ducha a flexibles.

Adaptor elbow for handshowers to shower hoses.

Bolsa - Bag: 125 x 143 x 30 mm

ACCESORIOS / ACCESSORIES



Anillas para cortina - Curtain rings

Cod. Barras / Bar Code	Ref.	Color / Colour	U/
8410787026612	50070402	○	20 1,66€
8410787026629	50070411	⊕	20 1,97€

Envase con 15 unidades.

Pack with 15 units.

Bolsa - Bag: 125 x 143 x 30 mm



Cadena de sujeción - Support chain to the ceiling

Cod. Barras / Bar Code	Ref.	Color / Colour	U/
8410787026599	50070214	○	20 2,41€

Para barra de cortina - Incluye todas las piezas para su instalación.

For curtain rod - All parts for installation are included.

Bolsa - Bag: 125 x 143 x 30 mm



Soporte para barra - Curtain rod support

Cod. Barras / Bar Code	Ref.	Color / Colour	U/
8410787026605	50070302	○	10 2,34€

Juego de 2 soportes para barras de cortina - Incluye todas las piezas para su instalación

2 curtain rod supports - All parts for installation are included.

Bolsa - Bag: 125 x 143 x 40 mm



Eje portarrollos - Tissue replacement

Cod. Barras / Bar Code	Ref.	Color / Colour	U/
8410787026919	50170102	○	15 1,58€

Eje portarrollos universal.

Tissue roller replacement.



Bolsa - Bag: 125 x 143 x 30 mm

Granel / Bulk products





Mangos de ducha / <i>Handshowers</i>	124
Difusores / <i>Shower heads</i>	126
Repuestos Columnas / <i>Columns Replacements</i>	126
Barra murales / <i>Slide bars</i>	126
Soportes y accesorios / <i>Supports and accessories</i>	127
Flexibles / <i>Shower hoses</i>	127
Barras de cortina / <i>Curtain rods</i>	128
Menaje / <i>Household ware</i>	129

Mangos de ducha / Handshowers

MASAJE / MASSAGE

Modelo	Ref	Funciones / Functions	Color	U/ 	Pag.	PVP € / € Pc.
Vanity	AE730014	4 Funciones / 4 Functions	○	24	16	19,53 €
Fox Five	AE790014	5 Funciones / 5 Functions	○	20	18	12,47 €
Shine 	AE850014	3 Funciones / 3 Functions	○	20	18	17,84 €
Party	AE740014	5 Funciones / 5 Functions	○	24	22	14,15 €
Holiday	AE710014	3 Funciones / 3 Functions	○	24	24	17,49 €
EcoWhite 2F	AE840017	2 Funciones / 2 Functions	○	20	26	13,78 €
Luxor Plus	AE170202	6 Funciones / 6 Functions	○	24	14	21,01 €
Luxor Plus	AE170214	6 Funciones / 6 Functions	○	24	14	23,32 €
Turbobath	AE060402	6 Funciones / 6 Functions	○	40	28	9,40 €
Turbobath	AE060414	6 Funciones / 6 Functions	○	40	28	12,35 €
Total 6	AE340002	6 Funciones / 6 Functions	○	40	29	8,56 €
Total 6	AE340014	6 Funciones / 6 Functions	○	40	29	11,26 €
Testa	AE620002	3 Funciones / 3 Functions	○	50	30	9,20 €
Testa	AE620014	3 Funciones / 3 Functions	○	50	30	12,43 €
Prisma	AE630002	3 Funciones / 3 Functions	○	80	30	9,20 €
Prisma	AE630014	3 Funciones / 3 Functions	○	80	30	12,43 €
Niágara	AE520002	3 Funciones / 3 Functions	○	50	32	7,89 €
Niágara	AE520014	3 Funciones / 3 Functions	○	50	32	10,35 €
Symbol	AE530002	3 Funciones / 3 Functions	○	50	33	7,89 €
Symbol	AE530014	3 Funciones / 3 Functions	○	50	33	10,35 €
Cyclone	AE120001	3 Funciones / 3 Functions	●	50	34	7,69 €
Cyclone	AE120002	3 Funciones / 3 Functions	○	50	34	7,69 €
Cyclone	AE120014	3 Funciones / 3 Functions	○	50	34	9,84 €
Select	AE260001	3 Funciones / 3 Functions	●	50	35	7,17 €
Select	AE260002	3 Funciones / 3 Functions	○	50	35	7,17 €
Select	AE260014	3 Funciones / 3 Functions	○	50	35	8,40 €

ANTICAL / ANTI-LIME

Modelo	Ref	Funciones / Functions	Color	U/ 	Pag.	PVP € / € Pc.
Colors	AE690014	1 Función / 1 Function	○	20	36	32,34 €
Style	AE670014	1 Función / 1 Function	○	75	38	9,35 €
Space	AE680014	1 Función / 1 Function	○	75	39	9,38 €
Stone	AE650014	1 Función / 1 Function	○	30	40	21,01 €
Stone	AE650017	1 Función / 1 Function	○	30	40	21,01 €
Happy	AE450014	1 Función / 1 Function	○	30	42	12,80 €
Rainbow 	AE880002	1 Función / 1 Function	○	30	42	14,11 €
Rainbow 	AE880004	1 Función / 1 Function	●	30	42	14,11 €
Rainbow 	AE880006	1 Función / 1 Function	●	30	42	14,11 €
EcoWhite	AE830017	1 Función / 1 Function	○	20	44	11,76 €
Fox	AE780014	1 Función / 1 Function	○	20	46	10,40 €
Forum	AE460014	1 Función / 1 Function	○	10	48	18,61 €
Eclipse	AE180014	1 Función / 1 Function	○	24	49	14,50 €

Mangos de ducha / Handshowers

ANTICAL / ANTI-LIME

Modelo	Ref	Funciones / Functions	Color	U/ 	Pag.	PVP € / € Pc.
Navy	AE540031	1 Función / 1 Function	●	65	50	6,82 €
Navy	AE540002	1 Función / 1 Function	○	65	50	6,82 €
Navy	AE540014	1 Función / 1 Function	◐	65	50	8,81 €
Swing	AE550031	1 Función / 1 Function	●	65	51	6,82 €
Swing	AE550002	1 Función / 1 Function	○	65	51	6,82 €
Swing	AE550014	1 Función / 1 Function	◐	65	51	8,81 €
Centric	AE130001	1 Función / 1 Function	●	75	-	5,64 €
Centric	AE130002	1 Función / 1 Function	○	75	-	5,64 €
Centric	AE130014	1 Función / 1 Function	◐	75	-	7,84 €
Optima	AE060002	1 Función / 1 Function	○	50	52	5,74 €
Optima	AE060014	1 Función / 1 Function	◐	50	52	7,94 €
Climax	AE350002	1 Función / 1 Function	○	50	53	5,74 €
Climax	AE350014	1 Función / 1 Function	◐	50	53	7,94 €
Juliet	AE270001	1 Función / 1 Function	●	60	54	5,65 €
Juliet	AE270002	1 Función / 1 Function	○	60	54	5,53 €
Juliet	AE270014	1 Función / 1 Function	◐	60	54	7,64 €

LLUVIA / RAIN

Modelo	Ref	Funciones / Functions	Color	U/ 	Pag.	PVP € / € Pc.
Comfort	AE060101	1 Función / 1 Function	●	50	55	4,77 €
Comfort	AE060102	1 Función / 1 Function	○	50	55	4,77 €
Comfort	AE060114	1 Función / 1 Function	◐	50	55	6,61 €
Neo	AE560031	1 Función / 1 Function	●	75	56	5,11 €
Neo	AE560002	1 Función / 1 Function	○	75	56	5,11 €
Neo	AE560014	1 Función / 1 Function	◐	75	56	7,12 €
Soul	AE570031	1 Función / 1 Function	●	65	57	5,11 €
Soul	AE570002	1 Función / 1 Function	○	65	57	5,11 €
Soul	AE570014	1 Función / 1 Function	◐	65	57	7,12 €
Princess	AE280001	1 Función / 1 Function	○	60	58	3,38 €
Princess	AE280002	1 Función / 1 Function	◐	60	58	3,38 €
Princess	AE280014	1 Función / 1 Function	◑	60	58	4,81 €
Polo	AE580031	1 Función / 1 Function	●	75	59	2,04 €
Polo	AE580002	1 Función / 1 Function	○	75	59	2,04 €
Polo	AE580014	1 Función / 1 Function	◐	75	59	4,38 €
Golf	AE0531	1 Función / 1 Function	●	75	60	1,47 €
Golf	AE0532	1 Función / 1 Function	○	75	60	1,47 €
Golf	AE0504	1 Función / 1 Function	●	75	60	1,54 €
Golf	AE0505	1 Función / 1 Function	●	75	60	1,54 €
Golf	AE0506	1 Función / 1 Function	●	75	60	1,54 €
Golf	AE0507	1 Función / 1 Function	●	75	60	1,54 €
Golf	AE050014	1 Función / 1 Function	◐	75	60	3,38 €
Cartoon	AE590029	1 Función / 1 Function	◑	75	61	9,48 €
Cartoon	AE590030	1 Función / 1 Function	◑	75	61	9,48 €
Guay Mango Infantil	AE040199	1 Función / 1 Function	◑	80	61	5,64 €
Junior	AE040002	1 Función / 1 Function	○	80	61	4,09 €
Junior	AE040014	1 Función / 1 Function	◐	80	61	5,11 €

Difusores / Shower heads

Modelo	Ref	Funciones / Functions	Color	U/ 	Pag.	PVP € / € Pc.
Splendid	AO00002	6 Funciones / 6 Functions	○	75	70	7,85 €
Splendid	AO00014	6 Funciones / 6 Functions	○	75	70	9,76 €
Tornado	AO05002	3 Funciones / 3 Functions	○	75	70	6,66 €
Tornado	AO05014	3 Funciones / 3 Functions	○	75	70	8,11 €
Rain	AO01002	1 Función / 1 Function	○	90	71	5,25 €
Rain	AO01014	1 Función / 1 Function	○	90	71	6,67 €
Dynamic	AO06002	1 Función / 1 Function	○	90	71	3,95 €
Dynamic	AO06014	1 Función / 1 Function	○	90	71	5,41 €
Energy	AO03002	1 Función / 1 Function	○	90	71	4,43 €
Energy	AO03014	1 Función / 1 Function	○	90	71	5,77 €
Impact	AO08002	1 Función / 1 Function	○	90	71	4,11 €
Impact	AO08014	1 Función / 1 Function	○	90	71	5,49 €
Mini	AO04002	1 Función / 1 Function	○	100	122	1,99 €
Finger	CC040014		○	80	122	4,92 €

Repuestos Columnas / Columns Replacements

Modelo	Ref	Color	U/ 	Pag.	PVP € / € Pc.
Chess: Grifo / <i>Faucet</i>	CB9837	○	1	63	76,65 €
Chess: Intercambiador / <i>3 Way valve</i>	CB9836	○	1	62	42,00 €
Future Tower: Intercambiador / <i>3 Way valve</i>	CB9777	○	1	64-65	42,00 €
Folk: Intercambiador / <i>3 Way valve</i>	CB9863	○	1	67	42,00 €
Tango: Intercambiador / <i>3 Way valve</i>	CB9864	○	1	68	42,00 €
Folk: Cursor / <i>Shower support</i>	CB9843	○	1	67	8,40 €
Chess Tango: Rociador / <i>Overhead</i>	CB9838	○	1	63-66	43,00 €
Folk: Rociador / <i>Overhead</i>	CB9844	○	1	68	47,72 €
Flexo Columna / <i>Columns shower hose</i>	AF9804	○	1	62-67	7,98 €

Soportes para mango / Handshower supports

BARRAS MURALES / SLIDE BARS

Modelo	Ref	Medidas / Sizes	Color	U/ 	Pag.	PVP € / € Pc.
Lasser con Jabonera	CB06002	80 cm	○	10	72	20,48 €
Lasser con Jabonera	CB06014	80 cm	○	10	72	28,43 €
Placet	CB03002	70 cm - Ø 28 mm	○	10	72	15,82 €
Placet	CB03014	70 cm - Ø 28 mm	○	10	72	22,42 €
Actual	CB08014	70 cm	○	10	72	20,38 €
Practika	CB070014	75 cm - Ø 20 mm	○	10	72	15,01 €
Excalibur	CB1102	60 cm - Ø 20 mm	○	10	72	6,96 €
Excalibur	CB111414	60 cm - Ø 20 mm	○	10	72	11,41 €

Soportes para mango / Handshower supports

Modelo	Ref	Medidas / Sizes	Color	U/ 	Pag.	PVP € / € Pc.
Royal jabonera (Placet)	JD120314		○	50	72	7,25 €
Plus 20 jabonera (Excalibur)	JD120011		○	60	72	4,41 €
Cursor (Excalibur/ Practika)	CB001102		○	50	72	1,49 €
Cursor (Excalibur/Practika)	CB001114		○	50	72	2,80 €
Componentes Cursor (Placet)	CB030314		○	50	72	5,34 €
Componentes Cursor (Coral)	CB040314		○	50	72	7,89 €

SOPORTES / SUPPORTS

Modelo	Ref	Medidas / Sizes	Color	U/ 	Pag.	PVP € / € Pc.
Techno	AP060002	1/2"	○	100	73	3,18 €
Techno	AP060014	1/2"	○	100	73	4,52 €
Superform	AP000001	1/2"	●	100	73	3,18 €
Superform	AP000002	1/2"	○	100	73	3,18 €
Superform	AP000114	1/2"	○	100	73	4,81 €
Max	AP050001	1/2"	●	100	73	1,95 €
Max	AP050002	1/2"	○	100	73	1,95 €
Max	AP050014	1/2"	○	100	73	2,97 €
Practik	AP040001	1/2"	●	100	73	1,38 €
Practik	AP040002	1/2"	○	100	73	1,38 €
Practik	AP040014	1/2"	○	100	73	1,95 €
Avanti	AP010001	1/2"	●	100	73	1,13 €
Avanti	AP010002	1/2"	○	100	73	1,13 €
Avanti	AP010014	1/2"	○	100	73	1,49 €
SopORTE rótula tornillo / Swivel support	AP0014	1/2"	○	90	74	3,71 €
Rótula toma agua / Swivel support with outlet	CC0014	1/2" x 1/2"	○	100	74	16,89 €
Ducha Stop	AP030114	1/2" x 1/2"	○	20	74	3,62 €
Codo / Elbow	AP0200	1/2" x 1/2"	●	125	74	1,02 €
Codo / Elbow	AP0202	1/2" x 1/2"	○	125	74	1,02 €
Codo / Elbow	AP0201	1/2" x 1/2"	○	125	74	1,23 €
Tacos y tornillos / Screws & plugs (Combis)	TC000000		○	50		0,43 €
Tacos y tornillos / Screws & plugs (Variant)	TC000001		○	50		0,53 €
Toma de agua directa / Shower outlet	CC0314		○	20		7,35 €
Juntas	AS0001		●	150		0,06 €
Econoflow	RC000002		○	150		0,06 €
Tapón protector de rosca / Shower Cup	AS0301		⊕	100		0,13€

Flexibles / Shower hoses

METÁLICOS / METALLIC

Modelo	Ref	Medidas / Sizes	Color	U/ 	Pag.	PVP € / € Pc.
Aluflex	AF300002	1,75 m	○	20	71	11,81 €
Aluflex	AF300019	1,75 m	Ⓜ	20	71	11,85 €
Longflex	AF100214	Hasta 2 m - Up to 2 m	○	20	71	5,25 €
Longflex EAN-13 8410787026131	AF200214	Hasta 2 m - Up to 2 m	○	40	71	5,36 €

Flexibles / Shower hoses

METÁLICOS / METALLIC

Modelo	Ref	Medidas / Sizes	Color	U/ 	Pag.	PVP € / € Pc.
Superflex	AF080114	1,5 m	○	20	75	8,35 €
Superflex	AF080214	1,75 m	○	20	75	9,98 €
Superflex	AF080314	2 m	○	20	75	11,45 €
Superflex Plus	AF080414	1,75 m	○	20	75	11,07 €
Cromflex	CA0014	1,5 m	○	20	75	7,68 €
Cromflex	AF070214	1,75 m	○	20	75	8,19 €
Cromflex	CA0114	2 m	○	20	75	8,76 €

PLÁSTICO / PLASTIC

Modelo	Ref	Medidas / Sizes	Color	U/ 	Pag.	PVP € / € Pc.
Ultraflex	AF0702	1,5 m	○	20	76	6,97 €
Ultraflex	AF0721	1,5 m	○	20	76	6,76 €
Ultraflex	AF040202	1,75 m	○	20	76	7,51 €
Ultraflex	AF040214	1,75 m	○	20	76	7,51 €
Ultraflex	AF0402	2 m	○	20	76	8,09 €
Ultraflex	AF0414	2 m	○	20	76	8,09 €
Satinflex	AF090119	1,5 m	Ⓜ	20	76	12,95 €
Satinflex	AF090219	1,75 m	Ⓜ	20	76	13,56 €
Satinflex	AF090319	2 m	Ⓜ	20	76	14,16 €
Megaflex	AF030002	1,5 m	○	20	76	3,72 €
Megaflex	AF030014	1,5 m	○	20	76	3,72 €
Megaflex	AF030202	1,75 m	○	20	76	4,01 €
Megaflex	AF030214	1,75 m	○	20	76	4,01 €
Megaflex	AF030102	2 m	○	20	76	4,44 €
Megaflex	AF030114	2 m	○	20	76	4,44 €
Megaflex (2)	AF201011	1,75 m	Ⓜ	20	76	5,08 €
Megaflex (2)	AF202011	2 m	Ⓜ	20	76	5,34 €

Barras de cortina / Curtain rods

CURVAS / CURVED

Modelo	Ref	Medidas / Sizes	Color	U/ 	Pag.	PVP € / € Pc.
Habitat	BB060102	114/200 cm	○	20	77	23,75 €
Habitat	BB060109	114/200 cm	Ⓟ	20	77	30,89 €
Roundbath	BB070102	80x80 cm	○	10	77	18,38 €
Roundbath	BB070109	80x80 cm	Ⓟ	10	78	22,82 €
Roundbath	BB070202	90x90 cm	○	10	78	19,03 €
Roundbath	BB070209	90x90 cm	Ⓟ	10	78	23,47 €
Roundbath	BB070302	100x100 cm	○	10	78	19,21 €
Roundbath	BB070309	100x100 cm	Ⓟ	10	78	22,97 €

Barras de cortina / Curtain rods

CURVAS / CURVED

Modelo	Ref	Medidas / Sizes	Color	U/ 	Pag.	PVP € / € Pc.
Bath Plus	BB020502	70x70 cm	○	20	79	13,54 €
Bath Plus	BB020702	80x80 cm	○	20	79	14,06 €
Bath Plus	BB020709	80x80 cm	Ⓟ	20	79	17,24 €
Bath Plus	BB020602	90x90 cm	○	20	79	15,30 €
Easy	BB050302	70x114/190 cm	○	20	79	13,33 €
Easy	BB050309	70x114/190 cm	Ⓟ	20	79	15,03 €

RECTAS / STRAIGHT

Modelo	Ref	Medidas / Sizes	Color	U/ 	Pag.	PVP € / € Pc.
Springbath	BB010102	80/125 cm	○	30	80	10,22 €
Springbath	BB010109	80/125 cm	Ⓟ	30	80	11,71 €
Springbath	BB010202	105/170 cm	○	30	80	13,80 €
Springbath	BB010209	105/170 cm	Ⓟ	30	80	14,20 €
Springbath	BB010302	150/215 cm	○	20	80	14,93 €
Springbath	BB010309	150/215 cm	Ⓟ	20	80	16,91 €
Easy	BB050102	100/170 cm	○	30	80	9,89 €
Easy	BB050109	100/170 cm	Ⓟ	30	80	10,79 €
Easy	BB050202	150/210 cm	○	20	80	12,48 €
Easy	BB050209	150/210 cm	Ⓟ	20	80	14,14 €

Anillas para cortinas / Shower curtain rings

Modelo	Ref	Medidas / Sizes	Color	U/ 	Pag.	PVP € / € Pc.
Steff	AC0002	-	○	150	81	0,10 €
Steff	AC0011	-	Ⓡ	150	81	0,14 €

Menaje / Household ware

Modelo	Ref	Medidas / Sizes	Color	U/ 	Pag.	PVP € / € Pc.
Eje Portarrollos / Toilet replacement	AN0002		○	300	126	0,57 €

Bricolaje de fontanería / Plumbing products

Modelo	Ref	Medidas / Sizes	Color	U/ 	Pag.	PVP € / € Pc.
Valvula Click Clack / Click clack valve	G10056	11/4" x Ø 63 mm	○	10	100	26,23 €



Merchandising / *Merchandising*

Expositores para producto / *Product displays* 131

Plan de disposición de mercancía / *Merchandising layout plan* 134



**Expositor universal para blister /
Universal display for blister**

Cod. Barras / Bar Code	Ref.	U/ 
8410787025400	045617	1

257,33€

Fabricado en tubo de aluminio cromo mate - Medidas totales: 199 cm x 93 cm x 40 cm - Dos cabeceras disponibles - Otros accesorios: Ganchos (en juego de 5 uds) y cesta para producto.

Made of matte chromed aluminium tube - Total Sizes: 199 cm x 93 cm x 40 cm - Two different placards available - Other accessories: Hooks (set of 5 units) and product basket.



Ganchos / Hooks

Cod. Barras / Bar Code	Ref.	U/ 
8410787025431	045625	5

5,72€

Ganchos para expositor universal (en juego de 5 unidades) - Medida: 30 cm.

Hooks for universal display (set of 5 units) - length: 30 cm.



Cesta / Basket

Cod. Barras / Bar Code	Ref.	U/ 
8410787026025	045626	1

51,66€

Fabricada en tubo de aluminio cromo mate.

Made of matte chromed aluminium tube.



Cabecera duchas / Shower placard

Cod. Barras / Bar Code	Ref.	U/ 
8410787025424	045624	1

66,26€

Fabricada en PVC - Impresa a 4 tintas.

Made of PVC - Four inks printed.



**Cabecera Fontanería /
Plumbing placard**

Cod. Barras / Bar Code	Ref.	U/ 
8410787025417	045623	1

66,26€

Fabricada en PVC - Impresa a 4 tintas.

Made of PVC - Four inks printed



Panel expositor / Display panel

Cod. Barras / Bar Code	Ref.	U/
8410787025370	045631	1

75,00€

Panel expositor para columna de ducha - Fabricado en madera acabado rojo brillante - Incluye logotipo serigrafiado - No incluye Columna. Medidas: 120 cm x 30 cm x 0,20 cm.

Exhibition panel for shower column - Made of wood with bright red finish - Includes screen printed logo - Column not included Total sizes: 120 cm x 30 cm x 0.20 cm.

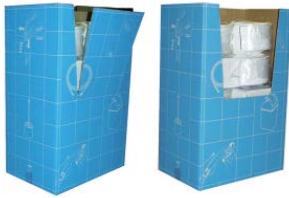

Minibox universal / Universal minibox

Cod. Barras / Bar Code	Ref.	U/
8410787020399	EB500001	1

43,05€

Fabricado en cartón - Medidas totales: 90 cm x 60 cm x 40 cm. Made of carton - Total Sizes: 90 cm x 60 cm x 40 cm.



Minibox serigrafiado / Serigraphed minibox

Cod. Barras / Bar Code	Ref.	U/
8410787023871	EB500002	1

48,30€

Fabricado en cartón brillo - Medidas totales: 90 cm x 60 cm x 40 cm. Made of bright finished carton - Total Sizes: 90 cm x 60 cm x 40 cm.



Caja expendedora / Expending box

Cod. Barras / Bar Code	Ref.	U/
8410787026056	EB500003	1

26,45€

Caja expendedora con tapa para conjuntos Variant - Fabricada en cartón - Medidas cerrada: 35,5 cm x 72 cm x 22 cm.

Expending box with cover for Variant sets - Made of cardboard - Sizes (closed): 35,5 cm x 72 cm x 22 cm.



Caja expendedora / Expending box

Cod. Barras / Bar Code	Ref.	U/
8410787026063	EB500004	1



26,45€

Caja expendedora con tapa para conjuntos Combi o flexos - Fabricada en cartón - Medidas cerrada: 31,5 cm x 31 cm x 23,5 cm.

Expending box with cover for Combi sets or shower hoses - Made of cardboard - Sizes (closed): 31,5 cm x 31 cm x 23,5 cm.



Exhibidor de sobremesa para 8 duchas / Universal Display for 8 handshowers



Cod. Barras / Bar Code	Ref.	Color / Colour	U/ 
8410787030435	EB500006		1 3,40€

Set expositor de duchas a granel compuesto por: 8 duchas modelo Party. Las duchas se sirven en el interior de la caja.

Exhibitor of bulk handshowers Made of bright finished carton. Handshowers not included - Total Sizes: 41,5 cm x 25 cm x 33,5 cm.



Mix 8 Rainbow

Cod. Barras / Bar Code	Ref.	Color / Colour	U/ 
8410787034938	EB880002		1 118,10€

Set expositor de duchas a granel compuesto por: 8 duchas modelo **Rainbow**. Las duchas se sirven en el interior de la caja.

*Exhibitor of bulk handshowers that includes: 8 units of **Rainbow** handshower. Handshowers are included inside the box.*



Mix 8 Party

Cod. Barras / Bar Code	Ref.	Color / Colour	U/ 
8410787030480	EB740014		1 124,34€

Set expositor de duchas a granel compuesto por: 8 duchas modelo **Party**. Las duchas se sirven en el interior de la caja.

*Exhibitor of bulk handshowers that includes: 8 units of **Party** handshower. Handshowers are included inside the box.*



Mix 8 Vanity

Cod. Barras / Bar Code	Ref.	Color / Colour	U/ 
8410787030473	EB730014		1 129,86€

Set expositor de duchas a granel compuesto por: 8 duchas modelo **Vanity**. Las duchas se sirven en el interior de la caja.

*Exhibitor of bulk handshowers that includes: 8 units of **Vanity** handshower. Handshowers are included inside the box.*



Mix 8 Stone

Cod. Barras / Bar Code	Ref.	Color / Colour	U/ 
8410787030466	EB650014		1 165,22€

Set expositor de duchas a granel compuesto por: 8 duchas modelo **Stone**. Las duchas se sirven en el interior de la caja.

*Exhibitor of bulk handshowers that includes: 8 units of **Stone** handshower. Handshowers are included inside the box.*



Mix 3 Party - 3 Vanity - 2 Stone

Cod. Barras / Bar Code	Ref.	Color / Colour	U/ 
8410787030497	EB990014		1 135,39€

Set expositor de duchas a granel compuesto por: 3 duchas modelo **Party**, 3 duchas modelo **Vanity** y 3 duchas modelo **Stone**. Las duchas se sirven en el interior de la caja.

*Exhibitor of bulk handshowers that includes: 3 units of **Party** handshower, 3 units of **Vanity** handshower and 2 units of **Stone** handshower. Handshowers are included inside the box.*

La mejor presentación para nuestros productos

En Interbath disponemos de un programa informático de implantación de mercancía con el que realizamos completos estudios de disposición de nuestros productos ajustados a las necesidades de espacio y gama requeridas por cada cliente.

El resultado de dicho estudio se presenta mediante una imagen a color y un listado que detalla, por orden de visualización, los datos más relevantes de la gama propuesta: Referencia, descripción, ubicación, unidades por gancho etc.

Gracias a este servicio, cualquier cliente puede disponer de esta ayuda para la colocación, visualización y valoración de los productos aún antes de realizar el pedido.



The best presentation for our products

At Interbath we have a merchandising program at our disposal which enables us to prepare complete studies of products arrangement according to our clients needs in terms of space and ranges required.

Studies are presented to the client through a colour image and a list detailing by display order the most relevant data of the proposed range: reference, description, location, units per hook.

Thanks to this application any client has at its disposal prior to placing the order a complete information concerning the positioning, display and valuation of products.

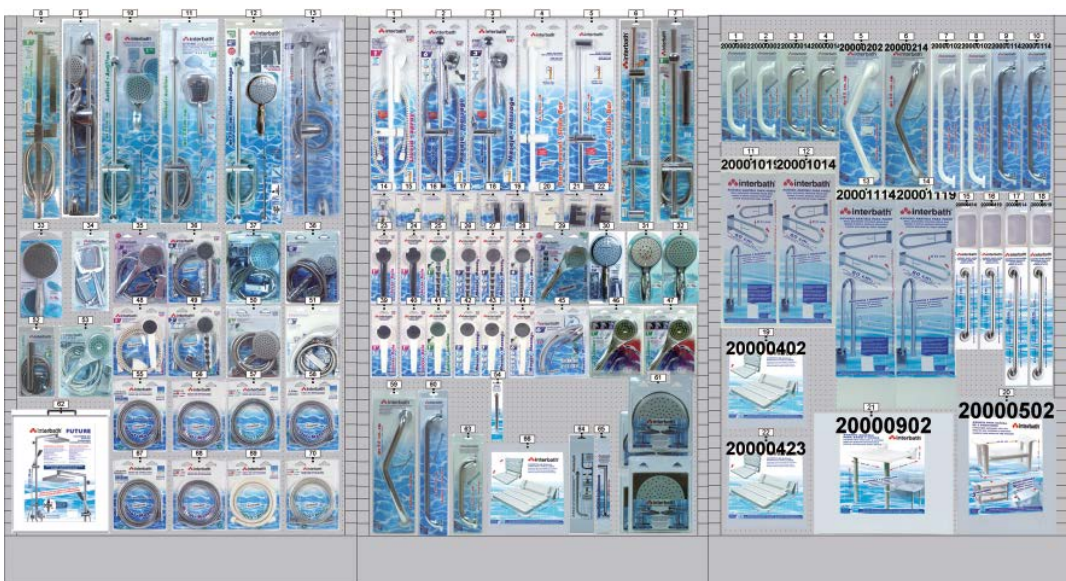

REF	PAG	REF	PAG	REF	PAG	REF	PAG	REF	PAG
45617	131	08060014	24	08840017	20	09044502	26	10020102	72
45623	131	08060202	48	08850014	14	09044514	26	10020201	72
45624	131	08060214	48	08880002	38	09044614	44	10020202	72
45625	131	08120002J	30	08880004	38	09044714	37	10021002	72
45626	131	08120014	30	08880006	38	09045202	28	10021014	72
45631	132	08170102	22	09032302	50	09045214	28	10022002	72
01107602	67	08170114	22	09032314	50	09045302	29	10022014	72
01107614	67	08180014	45	09032602	49	09045314	29	10070114	71
01107802	67	08220002	31	09032614	49	09045402	46	10080014	72
01107814	67	08220014	31	09033614	24	09045414	46	10090014	72
01107902	67	08230002	50	09033714	51	09045502	47	10100119	72
01107914	67	08230014	50	09034302	27	09045514	47	10100319	72
04010102	76	08240001J	54	09034314	27	09045602	52	10110102	71
04010109	76	08240002	54	09034502	26	09045614	52	11010102	78
04010202	76	08240014	54	09034514	26	09045702	53	11030102	78
04010209	76	08250002	25	09034714	37	09045714	53	11030104	78
04010302	76	08250014	25	09035502	47	09045802	55	11030105	78
04010309	76	08260002J	49	09035514	47	09045814	55	11030106	78
04020102	76	08260014	49	09035602	52	09045831	55	11030107	78
04020109	75	08350002	28	09035614	52	09045929	57	13010102	78
04020302	75	08350014	28	09035802	55	09045930	57	13010104	78
04020309	75	08360002	29	09035814	55	09046014	34	13010105	78
04020502	75	08360014	29	09036014	34	09046214	35	13010106	78
04020509	75	08370002	46	09036214	35	09046217	35	13010107	78
04020602	75	08370014	46	09036217	35	09046914	33	13019802	79
04020609	75	08380002	47	09036914	33	09047114	19	13019804	79
04030102	76	08380014	47	09037114	19	09047314	11	13019805	79
04030202	76	08390002	52	09037314	11	09047414	17	13019806	79
04030302	76	08390014	52	09040101	56	09047814	43	13019807	79
04060102	73	08400002	53	09040102	56	09047914	13	13019899	79
04060109	73	08400014	53	09040114	56	09048317	41	16000102	90
04070102	74	08410002	55	09040299	57	09048417	21	17010001	69
04070109	74	08410014	55	09040602	48	09048514	15	17010002	69
04070202	74	08410031	55	09040614	48	09048802	39	17010014	69
04070209	74	08420029	57	09040902	30	09048804	39	17010114	70
04070302	74	08420030	57	09040914	30	09048806	39	17010214	70
04070309	74	08430002	27	09041814	45	09051814	45	17010309	77
05010102	77	08430014	27	09042202	31	09052514	25	17010314	77
05030102	77	08450002	26	09042214	31	09058317	41	17010414	77
06010102	77	08450014	26	09042302	50	09058417	21	17010501	69
06010111	77	08460014	44	09042314	50	09062514	25	17010502	69
08010101	56	08470014	36	09042401	54	10010114	71	17010514	69
08010102	56	08620014	35	09042402	54	10010214	71	17010701	69
08010104	56	08620017	35	09042414	54	10010314	71	17010702	69
08010105	56	08690014	32	09042602	49	10011014	71	17010714	69
08010106	56	08710014	18	09042614	49	10011114	71	17010914	69
08010107	56	08730014	10	09043514	23	10011514	71	17011002	69
08010114	56	08740014	16	09043614	24	10011814	71	17011014	69
08020002	57	08780014	42	09043714	51	10011914	71	17020101	70
08020014	57	08790014	12	09044302	27	10012014	71	17020102	70
08060002	24	08830017	40	09044314	27	10020101	72	17020114	70

REF	PAG	REF	PAG	REF	PAG	REF	PAG	REF	PAG
17020202	67	50031214	110	50081902	115	88010036	96	88022316	102
17020214	67	50031302	112	50081914	115	88010048	96	88022348	102
17020302	67	50031314	112	50081931	115	88010056	96	88022400	105
17020314	67	50031402	114	50100002	120	88011156	96	88022410	105
17020402	67	50031414	114	50100014	120	88011158	96	88022430	107
17020414	67	50031702	111	50100102	120	88011316	96	88022490	105
17040102	68	50031714	111	50100114	120	88011318	96	88022550	105
17040114	68	50031902	115	50100214	121	88011538	99	88022600	106
17040314	68	50031914	115	50100314	121	88012038	100	88022650	106
17040414	68	50041202	110	50100402	120	88012050	100	88022800	102
17040514	68	50041214	110	50100431	120	88012068	100	88023250	108
17050102	78	50041302	112	50100502	120	88012108	100	88023387	108
19000102	90	50041314	112	50100531	120	88012148	100	88026000	107
19000302	90	50041402	114	50100614	121	88012198	100	88026010	107
20000002	84	50041414	114	50170014	122	88012279	100	88030003	102
20000014	84	50041514	116	50170102	122	88012308	100	88030004	94
20000102	84	50041614	116	50170202	121	88012518	100	88031012	106
20000114	84	50041702	111	50170214	121	88014038	98	88031015	107
20000214	85	50041714	111	50170231	121	88014069	98	88031027	107
20000302	85	50041731	111	50170314	119	88017110	103	88031030	107
20000314	85	50041802	113	50170402	119	88017120	103	88031111	107
20000402	87	50041814	113	50170414	119	88022000	104	88031162	107
20000414	83	50041831	113	50170502	121	88022006	105	88031166	106
20000423	87	50041901	115	50170514	121	88022018	105	88031179	106
20000514	83	50041902	115	50170531	121	88022021	102	88031180	106
20000602	86	50041914	115	50170614	119	88022029	101	88031203	106
20000802	86	50050014	117	50170702	118	88022034	107	88031204	106
20000902	87	50060014	117	50170714	118	88022036	101	88031206	107
20001014	81	50070214	122	50170802	118	88022044	103	88031289	106
20001114	81	50070302	122	50170914	118	88022045	103	88031302	102
20001302	89	50070402	122	8023250A	108	88022052	101	88031303	102
20001402	88	50070411	122	8023308A	108	88022053	101	96000107	127
20001502	89	50070502	122	88001188	95	88022070	105	AC0002	129
20001614	82	50070514	122	88001268	95	88022078	101	AC0011	129
22040314	70	50070531	122	88001586	94	88022088	101	AE040002	125
22040414	117	50081102	118	88001596	94	88022138	103	AE040014	125
22080314	66	50081114	118	88002128	95	88022140	102	AE040199	125
22080414	66	50081202	110	88004016	94	88022150	102	AE050014	125
22080514	66	50081214	110	88004036	95	88022160	103	AE0504	125
22090114	64	50081302	112	88004058	94	88022170	103	AE0505	125
22090214	64	50081314	112	88004096	94	88022195	104	AE0506	125
22090417	65	50081402	114	88004098	94	88022200	103	AE0507	125
22100114	61	50081414	114	88004126	95	88022210	103	AE0531	125
22100214	60	50081514	116	88005108	97	88022216	104	AE0532	125
22981014	63	50081614	116	88005508	98	88022228	104	AE060002	125
22981114	62	50081702	111	88006028	98	88022236	103	AE060014	125
22983514	58	50081714	111	88006088	98	88022242	104	AE060101	125
23010035	91	50081731	111	88006396	94	88022248	103	AE060102	125
50031102	118	50081802	113	88006398	94	88022250	101	AE060114	125
50031114	118	50081814	113	88006968	97	88022258	104	AE060402	124
50031202	110	50081831	113	88006978	97	88022260	104	AE060414	124

REF	PAG	REF	PAG	REF	PAG	REF	PAG	REF	PAG
AE120001	124	AE570031	125	AF080114	128	AP040002	127	CB030014	126
AE120002	124	AE580002	125	AF080214	128	AP040014	127	CB030314	127
AE120014	124	AE580014	125	AF080314	128	AP050001	127	CB060002	126
AE130001	125	AE580031	125	AF090119	128	AP050002	127	CB060014	126
AE130002	125	AE590029	125	AF090219	128	AP050014	127	CB070014	126
AE130014	125	AE590030	125	AF090319	128	AP060002	127	CB080014	126
AE170202	124	AE620002	124	AF100214	127	AP060014	127	CB1102	126
AE170214	124	AE620014	124	AF200214	127	AS0001	127	CB111414	126
AE180014	124	AE630002	124	AF201011	128	AS0301	127	CB9777	126
AE260001	124	AE630014	124	AF202011	128	BB010102	129	CB9836	126
AE260002	124	AE650014	124	AF300002	127	BB010109	129	CB9837	126
AE260014	124	AE650017	124	AF300019	127	BB010202	129	CB9838	126
AE270001	125	AE670014	124	AF9804	126	BB010209	129	CB9842	126
AE270002	125	AE680014	124	AN0002	129	BB010302	129	CB9843	126
AE270014	125	AE690014	124	AO000002	126	BB010309	129	CB9844	126
AE280001	125	AE710014	124	AO000014	126	BB020502	129	CB9863	126
AE280002	125	AE730014	124	AO010002	126	BB020602	129	CC0014	127
AE280014	125	AE740014	124	AO010014	126	BB020702	129	CC0314	127
AE340002	124	AE780014	124	AO030002	126	BB020709	129	CC040014	126
AE340014	124	AE790014	124	AO030014	126	BB050102	129	EB500001	132
AE350002	125	AE830017	124	AO040002	126	BB050109	129	EB500002	132
AE350014	125	AE840017	124	AO050002	126	BB050202	129	EB500003	132
AE450014	124	AE850014	124	AO050014	126	BB050209	129	EB500004	132
AE460014	124	AE880002	124	AO060002	126	BB050302	129	EB500006	133
AE520002	124	AE880004	124	AO060014	126	BB050309	129	EB650014	133
AE520014	124	AE880006	124	AO080002	126	BB060102	128	EB730014	133
AE530002	124	AF030002	128	AO080014	126	BB060109	128	EB740014	133
AE530014	124	AF030014	128	AP000001	127	BB070102	128	EB880002	133
AE540002	125	AF030102	128	AP000002	127	BB070109	128	EB990014	133
AE540014	125	AF030114	128	AP000114	127	BB070202	128	G10056	129
AE540031	125	AF030202	128	AP0014	127	BB070209	128	JD120011	127
AE550002	125	AF030214	128	AP010001	127	BB070302	128	JD120314	127
AE550014	125	AF0402	128	AP010002	127	BB070309	128	RC000002	127
AE550031	125	AF040202	128	AP010014	127	CA0014	128	TC000000	127
AE560002	125	AF040214	128	AP0200	127	CA0114	128	TC000001	127
AE560014	125	AF0414	128	AP0201	127	CA040314	127		
AE560031	125	AF0702	128	AP0202	127	CB001102	127		
AE570002	125	AF070214	128	AP030114	127	CB001114	127		
AE570014	125	AF0721	128	AP040001	127	CB030002	126		

PRECIOS: Los precios son de **VENTA AL PÚBLICO** (Recomendados) y pueden ser modificados sin previo aviso. Los precios no incluyen IVA.

EXPEDICIONES Y PEDIDOS: La mercancía viaja siempre por cuenta y riesgo del comprador.

Los pedidos serán siempre de cajas completas.

Las unidades mínimas de venta recogidas en la presente tarifa son de obligado cumplimiento, así como la venta por múltiplos de ésta.

En caso de que **JIMTEN, S.A.** autorice expresamente enviar unidades sueltas, tendrán un recargo del 20% en concepto de manipulación.

No se aceptarán pedidos inferiores a:

Península: 180€

Islas Baleares: 300€

Islas Canarias y Extranjero: 600€

Los pedidos a suministrar inferiores a estas cantidades, tendrán un cargo de 50€ sobre el importe neto de la venta en concepto de transporte, y gestión administrativa.

JIMTEN, S.A. no gestionará ningún envío a direcciones distintas al domicilio habitual del comprador.

ANULACIONES DE PEDIDOS: No se admiten anulaciones de pedidos que ya están fabricados o en curso de fabricación.

DEVOLUCIONES DE MATERIAL: No se admiten devoluciones de material, salvo en el caso de defecto imputable a la fabricación o a la gestión del transporte, en cuyo último caso el comprador deberá inspeccionar las mercancías de forma inmediata tras su recepción. Cualquier desperfecto reconocible en el transcurso de la inspección rutinaria y que sea asumible al transporte, deberá notificarse a Jimten por escrito en un plazo máximo de veinticuatro horas tras su recepción, no pudiendo ser atendidas las reclamaciones que excedan ese periodo.

CONDICIONES DE ENTREGA: Los pedidos podrán ser suministrados en parte sin que ello suponga la anulación de los mismos.

CALIDAD Y GARANTÍA: La garantía de nuestros materiales queda limitada a la reposición del producto, modelo o pieza que sea reconocida como defectuosa. Igualmente cubre todos los daños a terceros mediante póliza de responsabilidad civil, siempre y cuando se hayan observado las especificaciones y prescripciones para su uso correcto e instalación descritas en la documentación técnica del producto. Dado las características de los materiales cualquier reclamación de calidad, deberá plantearse dentro de los 15 días naturales siguientes a la entrega del material. Cualquier utilización o uso de nuestros materiales para fines distintos a los que fueron fabricados eximirá de cualquier tipo de responsabilidad.

PAGOS: Los precios de la Tarifa están considerados para pagos al contado. No obstante, previa clasificación del Comprador, se podrá optar a otras condiciones de mercado en el marco de las normas vigentes entre ellas la Ley 15/2010 de medidas contra la morosidad en las operaciones comerciales. Las letras de cambio, pagarés o cheques tan sólo se consideran aceptados por **JIMTEN, S.A.** en el momento en el que se hagan efectivos, no constituyendo en ningún caso la entrega de los mismos el cumplimiento de la obligación correspondiente.

Anexo 1: En caso de que la mora, la insolvencia o las deudas por parte del comprador hagan peligrar la solvencia de éste, **JIMTEN, S.A.** estará facultada para exigir de forma inmediata la liquidación de todas las cantidades adeudadas o la provisión de garantías, tanto en ese momento como en momentos futuros. **JIMTEN, S.A.** podrá realizar únicamente las entregas pendientes en caso de que éstas se hayan abonado por adelantado o se hayan presentado las garantías suficientes. En caso de que el comprador no pueda cumplir lo anterior en un periodo razonable de tiempo, **JIMTEN, S.A.** podrá rescindir el contrato de venta.

RESERVA DE PROPIEDAD: **JIMTEN, S.A.** conservará la propiedad de las mercancías suministradas hasta que se abone el pago total del correspondiente precio de compra y se liquiden la totalidad de las deudas pendientes por parte del comprador a **JIMTEN, S.A.** En los casos especificados en el Anexo 1, **JIMTEN, S.A.** también podrá impedir la tramitación y la reventa de la mercancía entregada con efectos inmediatos. Una declaración de rescisión del contrato por parte de **JIMTEN, S.A.** también se considerará una anulación de la autorización para revender y cobrar los derechos de reventa. En estos casos, **JIMTEN, S.A.** también podrá exigir la devolución inmediata de las mercancías entregadas por cuenta del comprador.

PROHIBICIÓN DE CESIÓN: El comprador tan solo podrá ceder los derechos y las deudas dimanantes de contratos de venta a terceros con el consentimiento previo de **JIMTEN, S.A.**

RESERVA: Nos reservamos el derecho a introducir modificaciones de diseño, medidas y unidades de embalaje en nuestros fabricados sin previo aviso.

COMPETENCIA JUDICIAL: Para resolver las cuestiones que puedan derivarse de la aplicación de estas Normas, tanto **JIMTEN, S.A.** como comprador, convienen someterse a los Juzgados y Tribunales de Alicante, renunciando a su propio fuero si fuese otro.

LIMITACIONES: Queda prohibida la reproducción total o parcial de esta tarifa sin la autorización expresa de **JIMTEN, S.A.**

Esta tarifa está sujeta a modificación sin previo aviso, todos los datos y especificaciones técnicas expresadas, se dan de buena fe y no tienen carácter contractual. Declinamos cualquier responsabilidad derivada de la aplicación de los mismos.

PRICES: Prices are retail prices (recommended) and can be modified without prior notice. Prices do not include VAT.

SHIPMENT AND ORDERS: Goods are shipped at buyer's own risk. Only full boxes can be ordered. Minimum units per order and their multiple established in this pricelist are binding. If loose units are specifically accepted by **JIMTEN, S.A.** and extra cost of 20% will be applied for less than full case picking. Orders lower than 300€. Will not be accepted. Orders lower than 600€, will have an extra cost of 50€ for transport and administrative work. **JIMTEN** will not manage any shipment to a different address than the customer usual one.

ORDERS CANCELLATION: Cancellations of orders already manufactured or under production will not be accepted.

RETURNS OF GOODS: Returns of goods are not accepted except when the defect is due to the manufacturing or transport management, in this last case the buyer must check the goods immediately after the reception. Any defect due to the transport must be notified to Jimten by written within 24 hours. Claims notified later will not be attended.

DELIVERY CONDITIONS: Partial orders deliveries do not suppose the order cancellation.

QUALITY AND WARRANTY: The warranty of our goods is limited to the replacement of the faulty product, model or piece. It covers as well the damages to third party thanks to a liability insurance only if the specifications for their correct use specified in the technical catalogue have been followed. Taking into account the material specificity, the quality claims must be notified within 15 days after the goods reception. Misuse of our products will exempt us of any responsibility.

PAYMENT: The prices on this pricelist are considered for payments on cash. However, and subject to a previous buyer's classification, you may be eligible for other payment conditions within the limits of the 15/2010 Law, Late Payments Directive. Bills of Exchange, Promissory Notes or Checks will only be considered as accepted by **JIMTEN S.A.** at the time they become effective, not in any way meaning their deliver to **JIMTEN**, the fulfilment of the corresponding obligation.

ANNEX 1: In case the delay, the insolvency or the debts of the buyer put its solvency at risk, **JIMTEN, S.A.** will be in position to demand immediately the payment of the overdue amount or a guarantee provision in that moment or in the future. Jimten will be in position to deliver the pending consignments in case they are paid in advance or enough guarantees have been presented. If the buyer cannot fulfill the previous statement in a reasonable period of time, **JIMTEN, S.A.** will be in position to cancel the sales contract.

RESERVATION OF TITLE: The products supplied will be the property of **JIMTEN, S.A.** until they are fully paid and all debts of the buyer are settled. In cases specified in Annex 1 **JIMTEN, S.A.** will be in position to prevent the resale of the delivered goods with immediate effect. A contract cancellation declaration by **JIMTEN** will be considered as well as an authorization cancellation to resale and charge the resale rights. In that cases **JIMTEN, S.A.** will be in position to demand the immediate return of the goods delivered by the buyer.

CESSION PROHIBITION: The buyer shall be only entitled to cede the rights and debts arising from sales contract to third party with previous **JIMTEN** agreement.

RESERVATION: We reserve the right to modify our products designs, dimensions and units per box without prior notice.

PLACE OF JURISDICTION AND GOVERNING LAW: In case of dispute **JIMTEN, S.A.** and the buyer consent to the jurisdiction of Alicante courts and waive their own jurisdiction if different.

RESTRICTIONS: Total or partial reproduction of this price list is prohibited without **JIMTEN** express authorisation. This price list can be modified without prior notice and do not have a contractual capacity. Data is given in good faith. We refuse any liability arisen from its application.

Certificado del Sistema de Gestión de la Calidad



ER-0084/1996

AENOR, Asociación Española de Normalización y Certificación, certifica que la organización

JIMTEN, S.A.

dispone de un sistema de gestión de la calidad conforme con la Norma UNE-EN ISO 9001:2008

para las actividades: El diseño, el desarrollo y la producción de productos en materiales plásticos para la edificación y el transporte de fluidos, productos inyectados y estampados.

que se realizan en: CR DE OCAÑA, 125 03114 - ALICANTE

Fecha de emisión: 1996-03-04
 Fecha de renovación: 2013-10-22
 Fecha de expiración: 2016-10-22

AENOR Asociación Española de Normalización y Certificación
 Avelino BRITO MARQUINA
 Director General de AENOR

 Asociación Española de Normalización y Certificación | Génova 6, 28004 Madrid, España | Tel. 902 332 222 - www.aenor.es
 Entidad de certificación de sistemas de gestión de la calidad acreditada por ENAC con acreditación N° 1253-9028
— AENOR es miembro de la RED IQRNet (Red Internacional de Certificación) —



CERTIFICATE

IQNet and AENOR hereby certify that the organization

JIMTEN, S.A.

CR DE OCAÑA, 125 03114 - ALICANTE España

for the following field of activities

The design and development and the production of products made of plastic, for building and transport of fluids, injected and stamped products.

has implemented and maintains a

Environmental Management System

which fulfils the requirements of the following standard

ISO 14001:2004

First issued on: 1999-11-26 Renewed on: 2013-10-22 Validity date: 2016-10-22

Registration Number: ES-1999/0156

 Michael Drechsel
 President of IQNet

AENOR Asociación Española de Normalización y Certificación
 Avelino BRITO
 Chief Executive Officer

IQNet Partners: AENOR Spain; AFNOR Certification; Procter and Gamble International; Belgica; ANICE Mexico; ANICER Portugal; CCC Cignus; CSRI; Huij-COC; China; IQIM China; COC Brazil; Pipelife; Con-Crete; DSG Holding GmbH; Germany; DSI Denmark; FCAV Brazil; FUNDACIONIA Venezuela; ICORTEL Colombia; INDC Mexico; INNORPFI Russia; Inspeco Certification; Proband DREAM Argentina; RQA Japan; KPII Korea; IMETT Hungary; Rivalco AS Norway; NEM Ireland; PQCPC Poland; Quality Assurance Austria; WRI Australia; ISI Israel; BQI Slovenia; IQRIM QAS International; Malaysia; BQS Switzerland; SBACB Romania; TQST By Prevedence Romania; TSE Thailand; TQIGI Serbia.
 IQNet is represented in the USA by: AENOR Certification, CSRI, DSG Holding GmbH and NEM Inc.
 The list of IQNet partners is valid at the time of issue of this certificate. Updated information is available under www.iqnet-certification.com

Certificado del Sistema de Gestión Ambiental



GA-1999/0156

AENOR, Asociación Española de Normalización y Certificación, certifica que la organización

JIMTEN, S.A.

dispone de un sistema de gestión ambiental conforme con la norma UNE-EN ISO 14001:2004

para las actividades: El diseño, el desarrollo y la producción de productos de materiales plásticos para la edificación y el transporte de fluidos, productos inyectados y estampados.

que se realizan en: CR DE OCAÑA, 125 03114 - ALICANTE

Fecha de emisión: 1999-11-26
 Fecha de renovación: 2013-10-22
 Fecha de expiración: 2016-10-22

AENOR Asociación Española de Normalización y Certificación
 Avelino BRITO MARQUINA
 Director General de AENOR

 Asociación Española de Normalización y Certificación | Génova 6, 28004 Madrid, España | Tel. 902 332 222 - www.aenor.es
 Entidad de certificación de sistemas de gestión ambiental acreditada por ENAC con acreditación N° 1253-9028
— AENOR es miembro de la RED IQRNet (Red Internacional de Certificación) —

140



NOTA: Los datos facilitados en este catálogo, como consecuencia de la constante mejora y evolución de nuestros productos, pueden variar sin previo aviso. Este catálogo no tiene carácter contractual, y toda la información se da de buena fe. Declinamos cualquier responsabilidad derivada de la aplicación de los mismos.

La versión más actualizada de este catálogo lo encontrará disponible en nuestra página web:

NOTE: The data provided in this catalogue, as a result of continuous improvement and development of our products, may change without any prior notice. This catalogue is not legally binding, and all information is given in good faith. We do not accept any liability for the application of this data.

The most recent version of this catalogue is available in our web site:

www.interbath.es



ER-0084/1996



GA-1999/0156



JIMTEN, S.A. empresa registrada según norma UNE-EN ISO 9002 • UNE-EN ISO 14001.

Todos nuestros productos, envases y embalajes, se producen bajo la filosofía de la utilización de tecnologías limpias, evitando el uso de elementos contaminantes. Además, en nuestra fabricación, seguimos las normas vigentes para conseguir un importante ahorro de agua y energía. Todas estas características convierten a los productos de Interbath en una verdadera alternativa ecológica.

JIMTEN, S.A. registered company by UNE-EN ISO 9002 • UNE-EN ISO 14001.

All our products and packaging are manufactured using clear technologies. This signifies that any contaminating elements in the manufacturing process are avoided. In addition to this, our products are manufactured following the norms as far as water and energy saving is concerned. All these characteristics turn the Interbath products in a real ecological alternative.



[t] +34 915 902 830

[f] +34 915 159 830



www.interbath.es

[e] oficina.centro@jimten.com

JIMTEN, SA

Ctra. de Ocaña, 125. C.P. 03114

Apdo. de Correos 5285. C.P. 03080

[t] +34 965 109 044

[f] +34 965 115 082

Alicante (España)

www.jimten.com

[e] international@jimten.com

Empresa registrada según norma



ER-5084/1996



GA-1999/0196